

## Basics of DIP Switches

### General Knowledge of DIP Switches

#### What is a DIP Switches ?

DIP switch is a miniature switch that is mounted onto printed circuit boards and used to make settings on electronic devices. The name "DIP switch" comes from having the same shape and array of terminals found in integrated circuits (dual inline package), thus abbreviated to DIP.

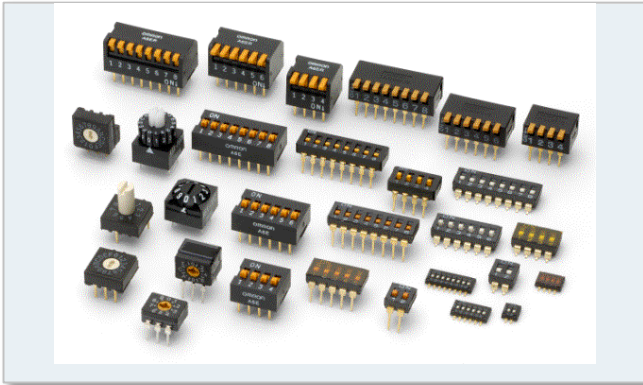

Figure 1 ● DIP switches

Most common DIP switch types include a sliding type, which uses a slider that moves between on and off to actuate, and a piano type, which uses "keys" that are pressed down to actuate. There is also a rotary type, which contains multiple contacts that a rotating actuator is aligned with to actuate and the contact positions are converted into a binary number or BCD (Binary Coded Decimal).

DIP switch is widely used in communication equipment, commercial equipment, and industrial equipment with optional features including surface mounting, assortment of poles, different actuator types, and sealing structure.

#### Features

<Miniature and low-profile>

The standard distance (pitch) between adjacent terminal pins of a DIP switch is 2.54mm. There is also an ultra-miniature half-pitch type with 1.27mm pitch to reduce the mounting space on PCBs. Others include low-profile types with heights of 2.2 mm and 1.55mm suitable for using with arrays of other low-profile electronic components in addition to the standard height of 3.5mm.

<High contact reliability>

Some of the DIP switch types have a self-cleaning function that ensures low contact resistance when the switch is turned on and off by making an instantaneous friction motion between the contacts to remove surface oxidation and contamination. DIP switches are not commonly used for frequent on-off switching; therefore it is designed to ensure high contact reliability while the switch is left unused for an extended period by utilizing a unique self-cleaning mechanism that scrapes off the contact surface during on-off switching as well as a structure with high contact pressure mechanism and contact pins plated with gold.

## Basics of DIP Switches

### General Knowledge of DIP Switches

<Auto mounting of switches>

In addition to a standalone package, stick packaging and taping packaging are available which allow mounting on PCBs automatically done in the same way as other electronic components.

## Types of DIP Switches

There are three actuator styles for DIP switches: slide, piano and rotary styles. All types have mounting options of either surface mount or through-hole PCB mounting. The slide DIP switches are available in flat or convex type actuator and piano DIP switches in short or long actuators (levers). The rotary DIP switches can be actuated by either vertical or horizontal (side) operation with either flat or shaft actuator. The DIP switches can also be customized for specific applications, including low-profile and half-pitch types to reduce mounting space, sealed construction type for high environmental resistance, and improved solder heat resistance capability to withstand temperature as high as 265 deg C (Figure 2).







	Slide type	Piano type	Rotary type
Through-hole PCB mounting	Flat/Convex actuators  Standard    High contact reliability    Sealed	Short/Long levers  Standard    Thin    Sealed	Flat/Shaft actuators  Standard    Sealed    Sealed Miniature
	Flat/Convex actuators  High contact reliability    Solder heat resistance    Miniature Thin Half-pitch	Short/Long levers  Thin    Miniature Half-pitch	Flat/Shaft actuators  Standard    Miniature

Figure 2 ● DIP switch types

## Basics of DIP Switches

### General Knowledge of DIP Switches

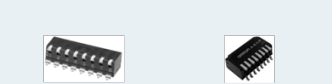
#### Basic Structure

The construction of a typical DIP switch is illustrated in figure 3. Basic parts of a DIP switch include: (1) cover (2) striker (3) slider and (4) base. The descriptions are described below.

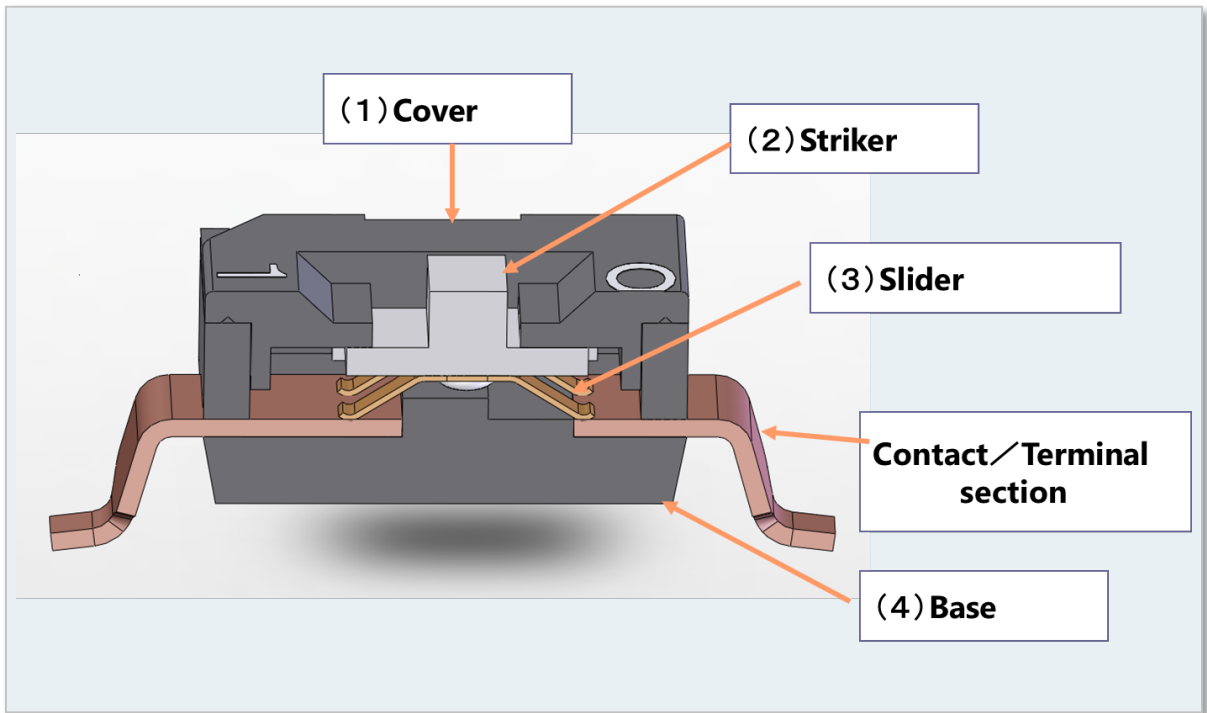

Figure 3 ● Basic structure of a DIP switches

#### (1) Cover

The switch cover is a resin injection molded parts which is attached to the base to protect the internal mechanism.

#### (2) Striker

DIP switch is operated by the striker. The striker ensures contact stability (closing and opening) by applying a load on the slider. Because the striker is too small to change its setting with your finger, tiny object with fine rounded tips, such as tweezers is used. There are two types of strikers: a convex type with the tip of the striker sticking out from the cover and a flat type with the striker positioned within the surface of the switch cover (Figure 4). The flat type is also available with a sealing tape added on the top surface to allow cleaning.

## Basics of DIP Switches

### General Knowledge of DIP Switches



Figure 4 ● Flat type (left) and Convex type (right)

#### (3) Slider

A slider is an elastic metal plate bent into a V-shape that constructs moving contact. Its movement is linked with the striker movement by electrically touching (close) and separating (open) from the stationary contact attached to the base allowing the switch to turn on and off.

#### (4) Base

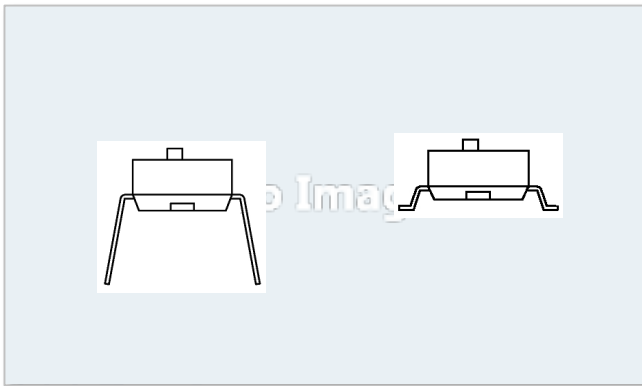
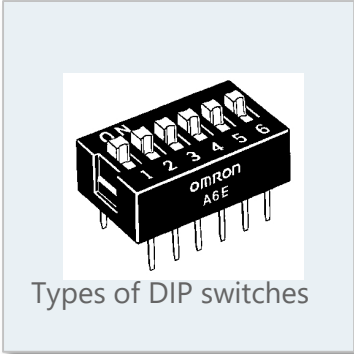

Figure 5 ● Through-hole PCB mounting (left) and Surface mount (right)

The switch base integrates the terminal and contact sections using a resin injection molding process. In this case, heat resistant resin is required to withstand the high soldering temperature. Terminal ends sticking out of the switch are connected internally to form a pair of stationary contacts. The shapes of terminals are available for either surface mount or through-hole PCB mounting (Figure 5). The stationary contact is plated with gold to ensure contact reliability.

## Basics of DIP Switches

### General Knowledge of DIP Switches



There is also a box-shaped DIP switch, which the joining area of the terminals sticking out from the rear side of the base and the resin injection molded parts is sealed with resin liquid to prevent flux penetration (Figure 6).

Figure 6 ● Box-shaped DIP switch

## Applications

- Mode settings of factory automation equipment and industrial machines

DIP switch is used to make settings of various operating and control modes for factory automation including servo controllers and temperature controllers as well as industrial machines including versatile automatic mounting systems.

- Configuration settings of computer peripherals and communication devices

DIP switch is used to select and make settings of pre-defined PCB configurations according to the user's desire, such as in computers, modems and storages.

- Address setting of equipment and machine connecting on network

DIP switch is used to make setting of each address of all things connecting on intelligence network such as IoT to identify each component, equipment, machine and device.

Please check each region's Terms & Conditions by region website.

## OMRON Corporation

Electronic and Mechanical Components Company

### Regional Contact

#### Americas

<https://www.components.omron.com/>

#### Asia-Pacific

<https://ecb.omron.com.sg/>

#### Korea

<https://www.omron-ecb.co.kr/>

#### Europe

<http://components.omron.eu/>

#### China

<https://www.ecb.omron.com.cn/>

#### Japan

<https://www.omron.co.jp/ecb/>