

An improved DIN-standard Sequence Connector

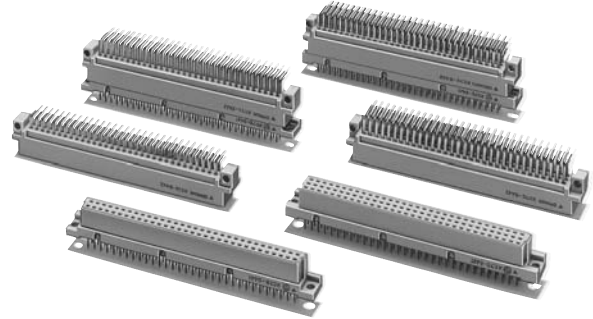

- Allows power line to daughter board connection first and removal last.
- Used the same way as regular DIN connectors. Dimensions are those of DIN B-type and C-type connectors. Mated length is 4 mm. All contacts are sequential contacts, an improvement on standard connectors.
- Sockets are equipped with 1-mm long sequential contacts. Sockets can be stacked up to 2 levels, and Plugs can be stacked up to 3 levels.
- Uses a double-sided contact design. Gold/palladium plating has an insertion durability of 5,000 cycles.
- See the "Standards certification / conformity list" for information on conformity to certification standards.

Note: Cannot be mated with XC5 and XC6 Series.

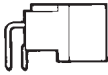
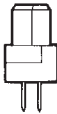

RoHS Compliant

■ Connectors

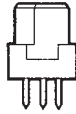
Model	XC7A	XC7B	XC7C	XC7D
Appearance	Plug with right-angle terminals 	Socket with straight terminals 	Plug with right-angle terminals 	Socket with straight terminals 
Page	2	3	4	5

■ Ratings and Characteristics

Rated current	2 A
Rated voltage	300 VAC
Contact resistance	20 mΩ max. (at 20 mV, 100 mA max.)
Insulation resistance	10 ⁶ MΩ min. (at 100 VDC)
Dielectric strength	1,000 VAC for 1 min (leakage current: 1 mA max.)
Total insertion force	1 N max. per contact
Removal force	0.2 N min. (with test gauge, t = 0.56 mm)
Insertion durability	5,000 times
Ambient operating temperature	-55 to 125°C (with no icing at low temperature)

■ Materials and Finish

Item	Plugs	Sockets
Housings	Fiber-glass reinforced PBT resin (UL94 V-0)/gray	
Contacts	Mating end	Phosphor-bronze/nickel base, gold/palladium plating
	Terminal	Phosphor-bronze/nickel base, gold flash plating

XC7A Double-row Plugs

■ Dimensions

(unit: mm)

XC7A-□□42-□□□□

(With right-angle DIP terminals)

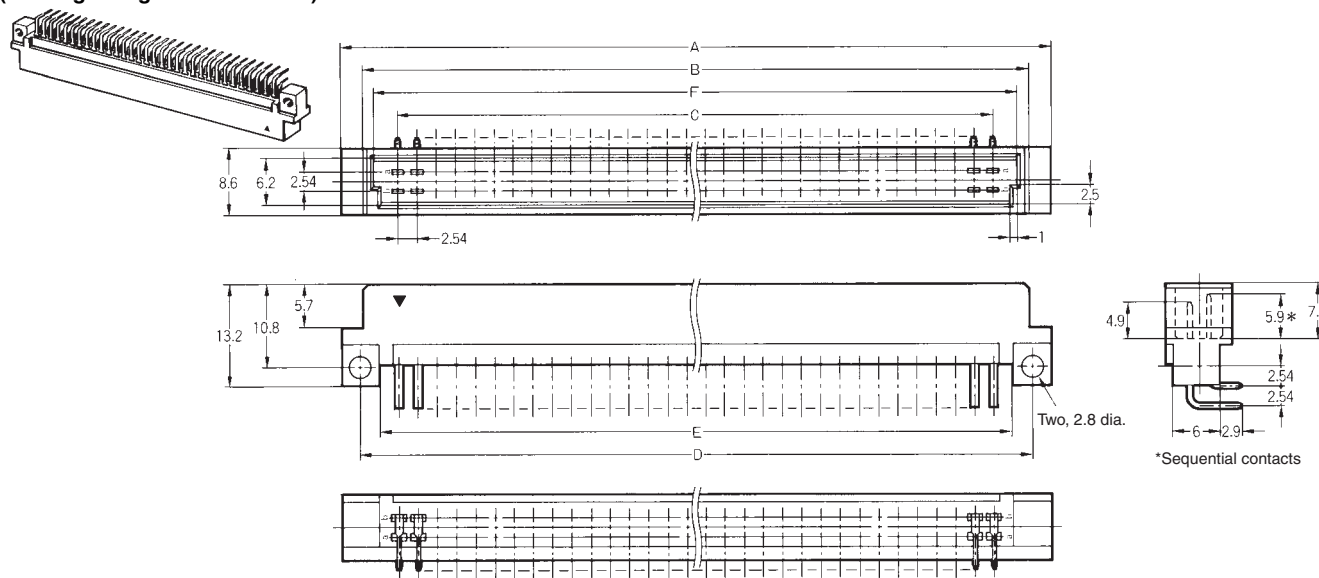

Mounting holes (bottom view)

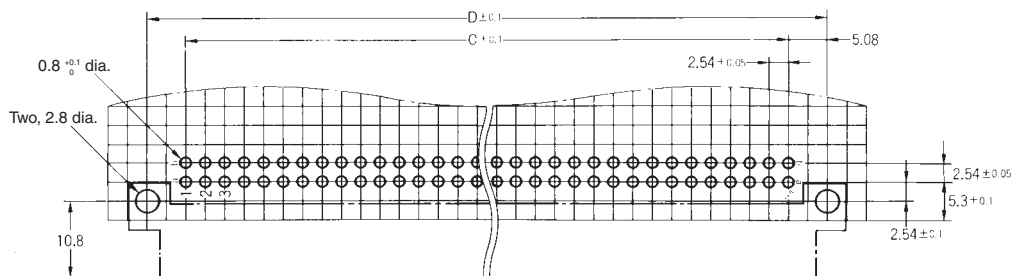

Dimensions

No. of contacts	Dimensions (mm)					
	A	B	C	D	E	F
64	93.8	88.0	78.74	88.9	83.9	85.2
90	126.8	121.0	111.76	121.9	117.0	118.2
100	139.5	133.7	124.46	134.6	129.7	130.9

■ Ordering Information

Appearance			
No. of contacts	Terminal type	Sequential contact position	Model
64	Right-angle DIP terminals	None	XC7A-6442
		All	XC7A-6442-N001
90		None	XC7A-9042
		All	XC7A-9042-N001
100		None	XC7A-0142
		All	XC7A-0142-N001

XC7B Double-row Sockets

Dimensions

(unit: mm)

XC7B-□□41-□□□□
(With straight DIP terminals)

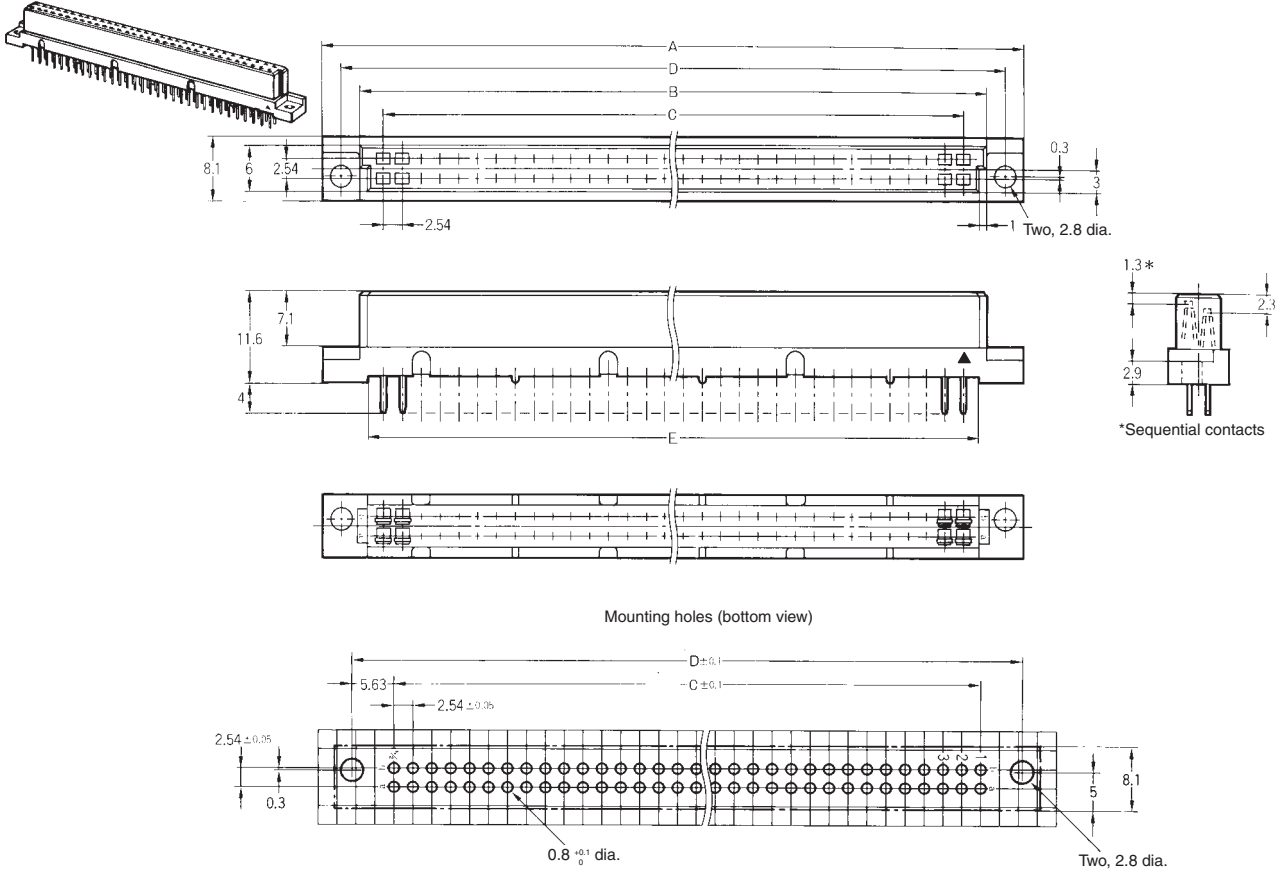

Mounting holes (bottom view)

No. of contacts	Dimensions (mm)				
	A	B	C	D	E
64	94.8	85.0	78.74	90.0	83.0
90	127.8	118.0	111.76	123.0	116.0
100	140.5	130.7	124.46	135.7	128.7

Ordering Information

Appearance			
No. of contacts	Terminal type	Sequential contact position	Model
64	Straight DIP terminals	a, b: 1 to 4	XC7B-6441-N003
		a, b: 26 to 32	
		All	XC7B-6441-N001
90		a, b: 1 to 4	XC7B-9041-N003
		a, b: 39 to 45	
100		All	XC7B-9041-N001
	a, b: 1 to 4	XC7B-0141-N003	
	a, b: 44 to 50		
	All	XC7B-0141-N001	

XC7C Triple-row Plugs

■ Dimensions

(unit: mm)

XC7C-9642-□□□□

(With right-angle DIP terminals)

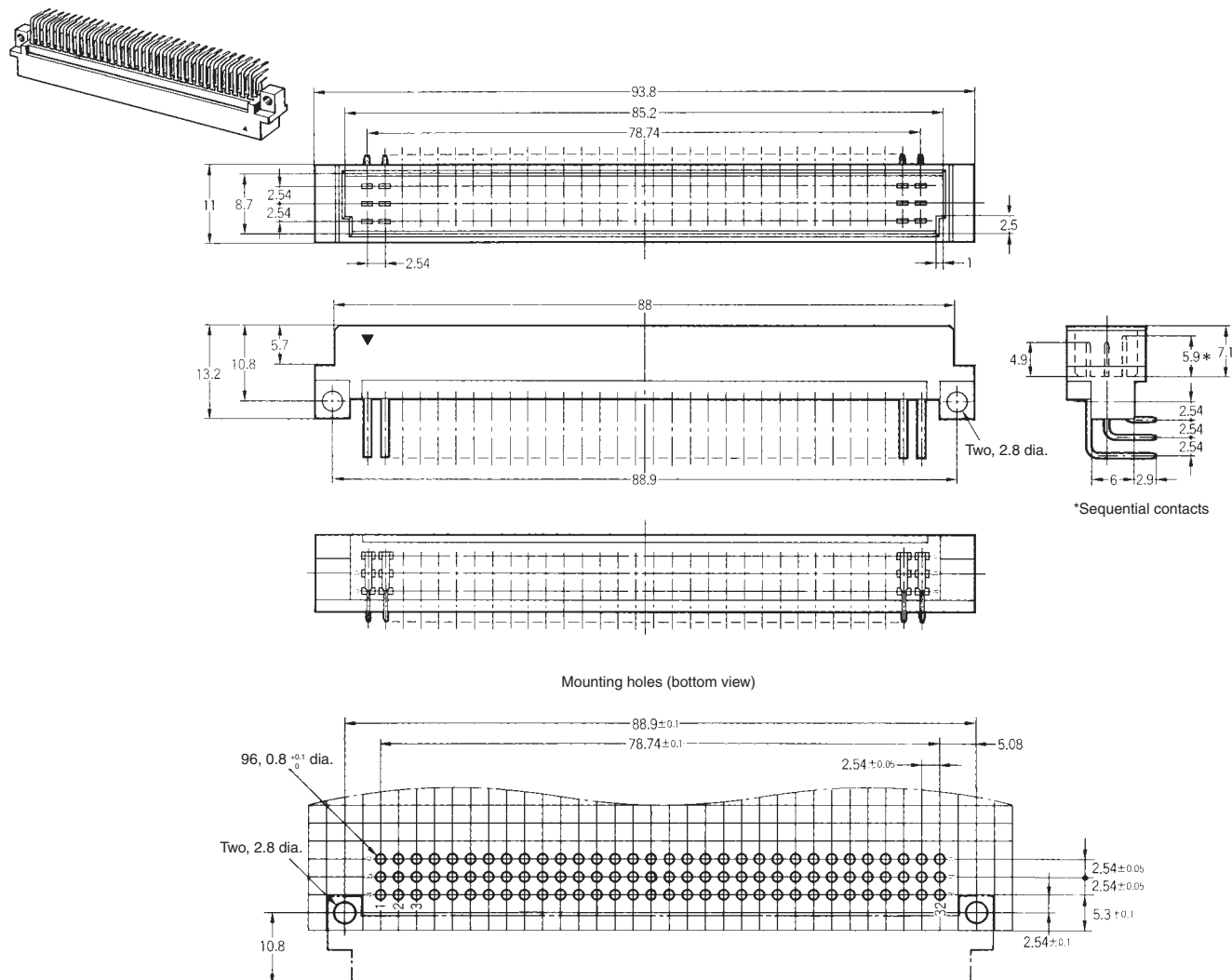

■ Ordering Information

Appearance			
No. of contacts	Terminal type	Sequential contact position	Model
96	Right-angle DIP terminals	All	XC7C-9642-N001
		None	XC7C-9642

XC7D Triple-row Sockets

■ Dimensions

(unit: mm)

XC7D-9641-□□□□

(With straight DIP terminals)

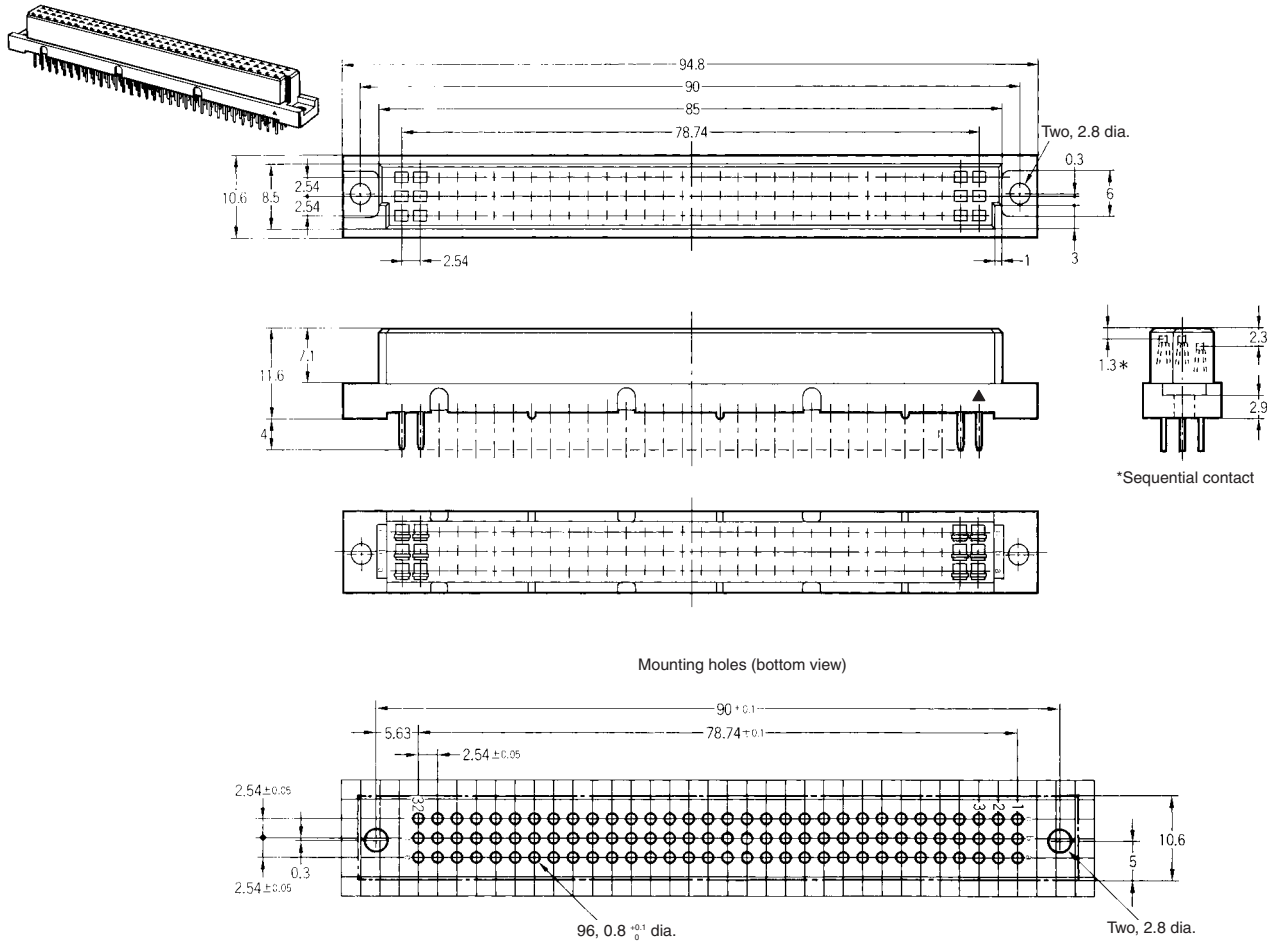

■ Ordering Information

Appearance			
No. of contacts	Terminal type	Sequential contact position	Model
96	Straight DIP terminals	All	XC7D-9641-N001
		a1, a32	XC7D-9641-N002

■ Mating Diagrams (unit: mm)

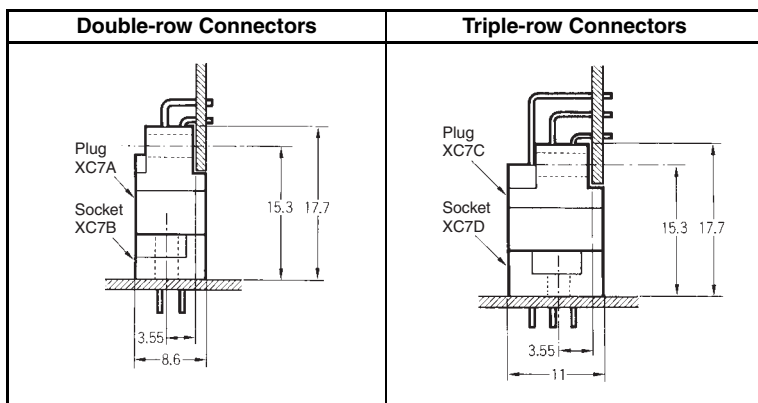

■ Mates with Standard DIN Connectors

- Dimensions are the same as those of standard DIN connectors XC5.
- The sequential contacts on the Socket and Plug are 1 mm long, so they cannot be interchanged with DIN Connectors. Use as a Socket/Plug pair.

■ Precautions

Correct Use

Automated soldering

Use masking tape to mask the Right-angle Connectors before automated soldering.

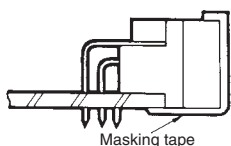

(Recommended tape: 3M Sumitomo #214)

Automated Soldering Conditions (Jet Flow)

1. Soldering temperature: $250 \pm 5^\circ\text{C}$
2. Continuous soldering time: Within 5 ± 1 s

Dimensions after Mounting

- Mounting dimensions for all Connectors should be as shown in the following diagram.

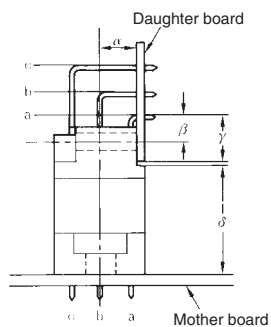

α : 3.55 mm

The distance between the center line of the mounting holes on the mother board and the daughter board. (This center line is shifted 0.3 mm toward row a from row b.)

β : 2.54 mm

The distance between the mounting holes on the daughter board and row a.

γ : 5.3 mm

The distance between the edge of the daughter board and row a.

δ : 12.4 to 14.2 mm

To insure reliability, be sure to keep the Connectors within these dimensions when mounting.

- The allowable margins for mating the Connectors are shown below.

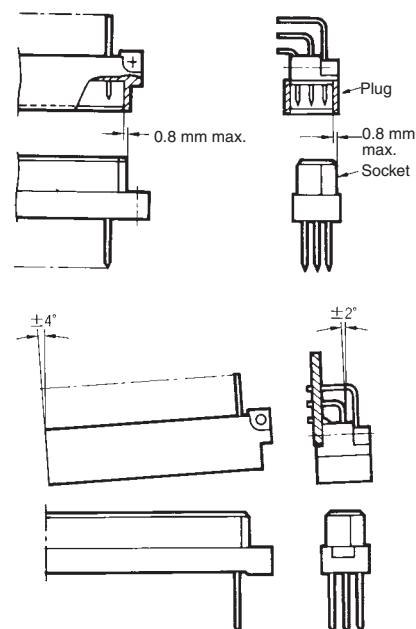

Please check each region's Terms & Conditions by region website.

OMRON Corporation
Electronic and Mechanical Components Company

Regional Contact

Americas

<https://www.components.omron.com/>

Asia-Pacific

<https://ecb.omron.com.sg/>

Korea

<https://www.omron-ecb.co.kr/>

Europe

<http://components.omron.eu/>

China

<https://www.ecb.omron.com.cn/>

Japan

<https://www.omron.co.jp/ecb/>