

G3VM-201G□/S5

MOS FET Relays SOP 4-pin, General-purpose Type

General-purpose MOS FET Relays in SOP 4-pin packages for a wide range of applications

- Load voltage: 200 V



Note: The actual product is marked differently from the image shown here.

Application Examples

- Semiconductor test equipment
- Security equipment
- Amusement equipment
- Test & Measurement equipment
- Industrial equipment
- Communication equipment
- Power circuit

Package

(Unit : mm, Average)

SOP 4-pin

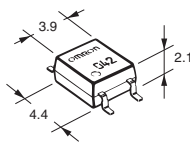

Note: The actual product is marked differently from the image shown here.

Model Number Legend

G3VM-□□□□
1 2 3 4

1. Load Voltage
20 : 200 V
2. Contact form
1 : 1a (SPST-NO)
3. Package
G : SOP 4-pin

4. Other informations

When specifications overlap, serial code is added in the recorded order.

Note: The model number legend for the G3VM-S5 is different from the above legend.

Ordering Information

Package	Contact form	Terminals	Load voltage (peak value) *	Continuous load current (peak value) *	Stick packaging		Tape packaging	
					Model	Minimum package quantity	Model	Minimum package quantity
SOP4	1a (SPST-NO)	Surface-mounting Terminals	200 V	50 mA	G3VM-201G	100 pcs.	G3VM-201G(TR)	2,500 pcs.
				200 mA	G3VM-201G1		G3VM-201G1(TR)	
					G3VM-201G2		G3VM-201G2(TR)	
					G3VM-S5		G3VM-S5(TR)	

* The AC peak and DC value are given for the load voltage and continuous load current.

Note: To order tape packaging for Relays with surface-mounting terminals, add "(TR)" to the end of the model number.

Absolute Maximum Ratings (Ta = 25°C)

Item		Symbol	G3VM-201G	G3VM-201G1	G3VM-201G2	G3VM-S5	Unit	Measurement conditions	
Input	LED forward current	IF	50		30	50	mA		
	Repetitive peak LED forward current	IFP	1					A	100 μs pulses, 100 pps
	LED forward current reduction rate	ΔIF/°C	-0.5		-0.3	-0.5	mA/°C	Ta ≥ 25°C	
	LED reverse voltage	VR	5					V	
Connection temperature		TJ	125					°C	
Load voltage (AC peak/DC)		V _{OFF}	200					V	
Output	Continuous load current (AC peak/DC)	I _o	50	200			mA		
	ON current reduction rate	ΔI _o /°C	-0.5		-2		mA/°C	Ta ≥ 25°C	
	Pulse ON current	I _{op}	150	600			mA	t=100 ms, Duty=1/10	
	Connection temperature	TJ	125					°C	
Dielectric strength between I/O *		V _{I-O}	1500					Vrms	AC for 1 min
Ambient operating temperature		Ta	-40 to +85					°C	With no icing or condensation
Ambient storage temperature		Tstg	-55 to +125			-55 to +100		°C	
Soldering temperature		-	260					°C	10 s

* The dielectric strength between the input and output was checked by applying voltage between all pins as a group on the LED side and all pins as a group on the light-receiving side.

SOP

G3VM-201G□/S5

■Electrical Characteristics (Ta = 25°C)

Item		Symbol	G3VM-201G	G3VM-201G1	G3VM-201G2	G3VM-S5	Unit	Measurement conditions
LED forward voltage	VF	Minimum	1.0		1.1	1.0	V	IF=10 mA
		Typical	1.15		1.27	1.15		
		Maximum	1.3		1.4	1.3		
Reverse current	IR	Maximum	10				μA	VR=5 V
Capacitance between terminals	CT	Typical	30				pF	V=0, f=1 MHz
Trigger LED forward current	IFT	Typical	1	0.4	–	1	mA	G3VM-201G : Io=50 mA G3VM-201G1/201G2/S5 : Io=200 mA
		Maximum	3	1	0.2	3		
Release LED forward current	IFC	Minimum	0.1		–	0.1	mA	IoFF=100 μA
		Typical	–		0.001	–		
Maximum resistance with output ON	RON	Typical	40	5			Ω	G3VM-201G/S5 : IF=5 mA, Io=Continuous load current ratings G3VM-201G1 : IF=2 mA, Io=200 mA G3VM-201G2 : IF=0.5 mA, Io=200 mA, t < 1s
		Maximum	50	8				
Current leakage when the relay is open	ILEAK	Typical	–	1		–	nA	G3VM-201G : VOFF=160 V G3VM-201G1/201G2/S5 : VOFF=200 V
		Maximum	1	1,000				
Capacitance between terminals	COFF	Typical	15	90		100	pF	G3VM-201G : V=0, f=1 MHz, t < 10s G3VM-201G1/201G2/S5 : V=0, f=1 MHz
		Maximum	20	–				
Capacitance between I/O terminals	CI-O	Typical	0.8				pF	f=1 MHz, VS=0 V
Insulation resistance between I/O terminals	RI-O	Minimum	1000				MΩ	VI-O=500 VDC, RoH≤60%
		Typical	10 ⁸					
Turn-ON time	tON	Typical	–	3	3.5	0.6	ms	G3VM-201G/S5 : IF=5 mA, RL=200 Ω, VDD=20 V * G3VM-201G1 : IF=2 mA, RL=200 Ω, VDD=20 V * G3VM-201G2 : IF=0.5 mA, RL=200 Ω, VDD=20 V *
		Maximum	0.5	8	10	1.5		
Turn-OFF time	tOFF	Typical	–	0.6	1	0.1	ms	G3VM-201G/S5 : IF=5 mA, RL=200 Ω, VDD=20 V * G3VM-201G1 : IF=2 mA, RL=200 Ω, VDD=20 V * G3VM-201G2 : IF=0.5 mA, RL=200 Ω, VDD=20 V *
		Maximum	0.2	3	5	1		

* Turn-ON and Turn-OFF Times

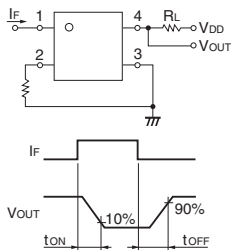

■Recommended Operating Conditions

For usage with high reliability, Recommended Operation Conditions is a measure that takes into account the derating of Absolute Maximum Ratings and Electrical Characteristics.

Each item on this list is an independent condition, so it is not simultaneously satisfy several conditions.

Item	Symbol		G3VM-201G	G3VM-201G1	G3VM-201G2	G3VM-S5	Unit
Load voltage (AC peak/DC)	VDD	Maximum	160			200	V
Operating LED forward current	IF	Minimum	5	–		5	mA
		Typical	7.5	2	0.5	7.5	
		Maximum	15	25			
Continuous load current (AC peak/DC)	Io	Maximum	40	160		130	
Ambient operating temperature	Ta	Minimum	–20				°C
		Maximum	65				

■Spacing and Insulation

Item	Minimum	Unit
Creepage distances	4.0	mm
Clearance distances	4.0	
Internal isolation thickness	0.1	

Engineering Data

LED forward current vs. Ambient temperature

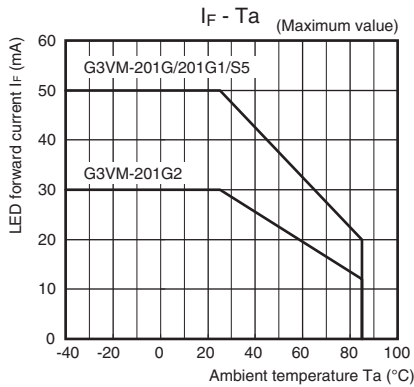

Continuous load current vs. Ambient temperature

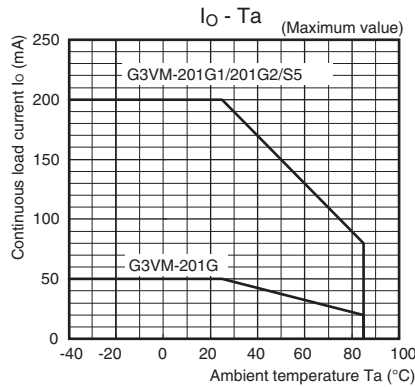

LED forward current vs. LED forward voltage

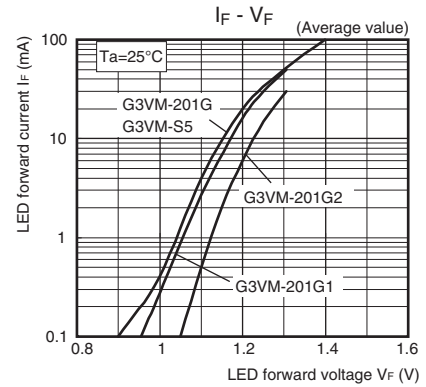

Continuous load current vs. On-state voltage

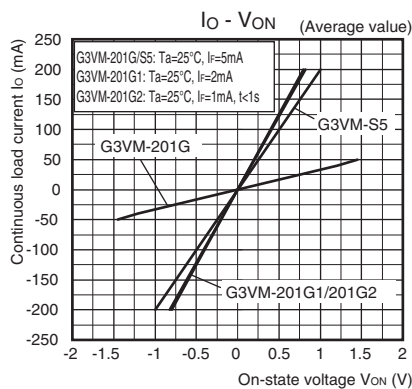

On-state resistance vs. Ambient temperature

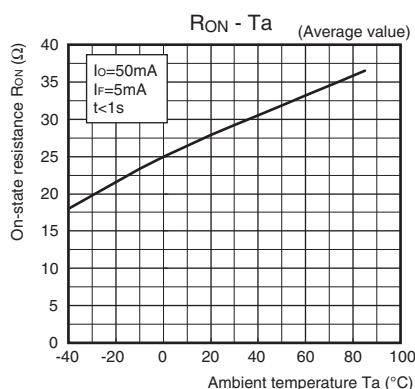

G3VM-201G1/201G2/S5

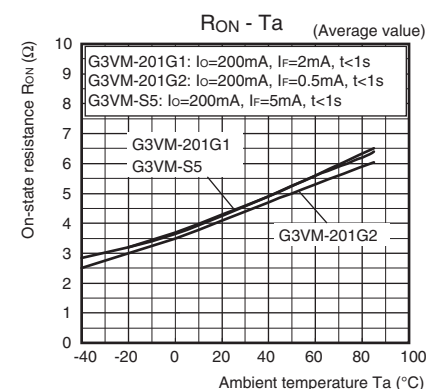

Trigger LED forward current vs. Ambient temperature

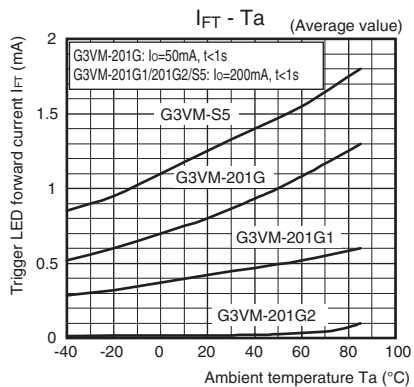

Turn ON, Turn OFF time vs. LED forward current

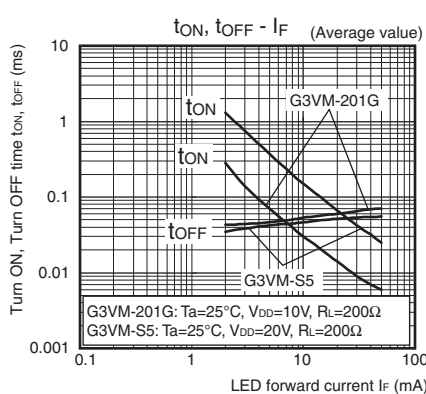

G3VM-201G1/201G2

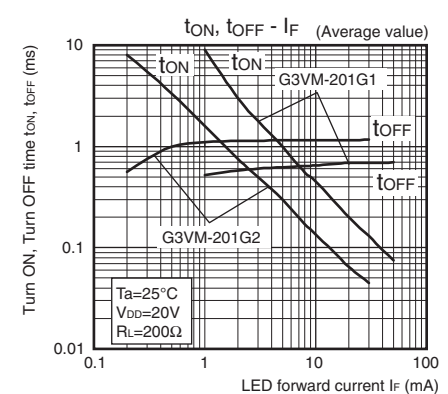

Engineering Data

● Turn ON, Turn OFF time vs. Ambient temperature G3VM-201G/S5

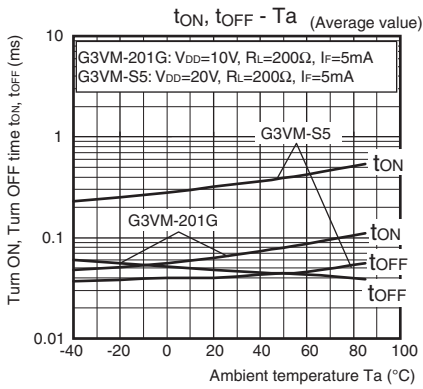

G3VM-201G1/201G2

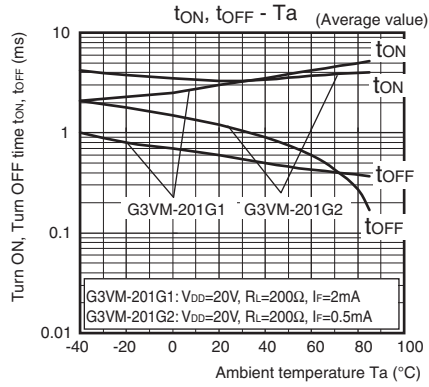

● Current leakage vs. Ambient temperature

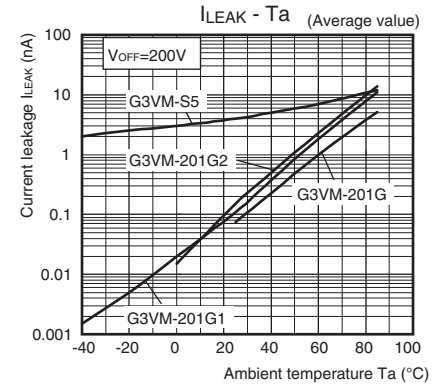

● Current leakage vs. Load voltage G3VM-201G2

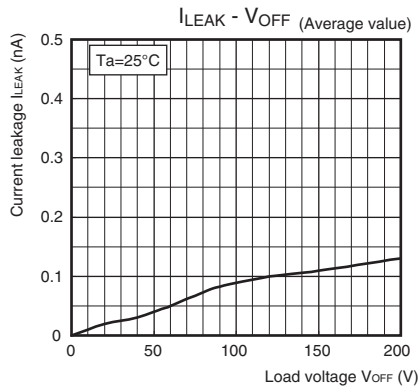

■ Appearance / Terminal Arrangement / Internal Connections

● Appearance

SOP (Small Outline Package)

SOP 4-pin

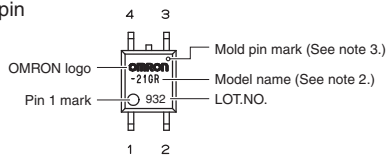

- Note: 1.** The actual product is marked differently from the image shown here.
- Note: 2.** "G3VM" does not appear in the model number on the Relay.
- Note: 3.** The indentation in the corner diagonally opposite from the pin 1 mark is from a pin on the mold.

● Terminal Arrangement/Internal Connections (Top View)

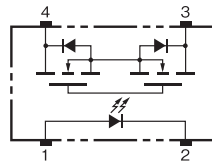

■ Dimensions (Unit: mm)

Surface-mounting Terminals

Weight: 0.1 g

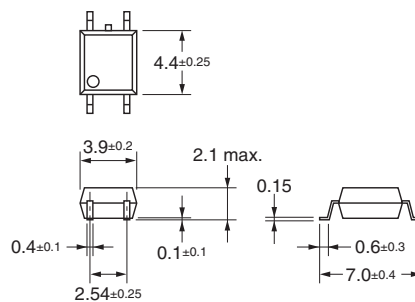

Actual Mounting Pad Dimensions

(Recommended Value, Top View)

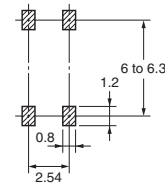

Note: The actual product is marked differently from the image shown here.

■ Approved Standards

UL recognized

Approved Standards	Contact form	File No.
UL (recognized)	1a (SPST-NO)	E80555

■ Safety Precautions

- Refer to the *Common Precautions for All MOS FET Relays* for precautions that apply to all MOS FET Relays.

Please check each region's Terms & Conditions by region website.

OMRON Corporation

Device & Module Solutions Company

Regional Contact

Americas

<https://components.omron.com/us>

Asia-Pacific

<https://components.omron.com/ap>

Korea

<https://components.omron.com/kr>

Europe

<https://components.omron.com/eu>

China

<https://components.omron.com.cn>

Japan

<https://components.omron.com/jp>