

## User-Friendly XW4M/N Push-In Terminal Block PCB Connectors with Unique Dual-Spring Structure\*1

### Introduction

Omron has released [XW4M/XW4N Push-In Terminal Block PCB Connectors](#). The new products are ideal for interfaces for industrial equipment. The unique dual-spring structure reduces insertion/removal force, ensures high contact reliability, and achieves efficient and smooth operations at sites.

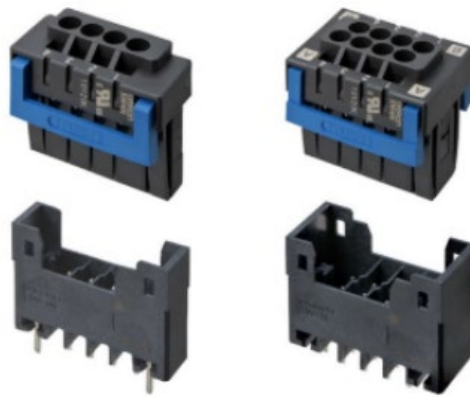

**Push-In Terminal Block PCB Connectors**

Currently, many manufacturers are facing labor shortfall issues primarily due to lack of emerging talent to replace a declining older adult workforce. In addition, the introduction of flexible production lines (that allow to change in product types/volume) require frequent adjustments/changes of the production lines. This labor intensive process puts productivity improvement heavily into focus, particularly for set-up and maintenance of manufacturing equipment. Furthermore, with the development of manufacturing technologies, the number of peripheral devices increases. In response to these trends, conventional screw-terminal blocks are being replaced with easy-to-use push-in terminal blocks for device interfaces that connect to sensors, actuators, etc.

Terminal block connectors are widely used because of the excellent workability. In contrast, conventional terminal block connectors require a large amount of insertion/removal force to ensure contact reliability during assembly, inspection, and maintenance processes, subsequently making it difficult to improve work efficiency with conventional terminal block connectors.





Omron's new [XW4M/XW4N products](#) improve work-efficiency significantly. The original dual-spring structure\*1 offers both a reduced need for force with easy insertion/removal (insertion/removal force reduced) and ensures high contact reliability during mating. The push-in method requires no tools for wiring or screwing after operations or shipping.

In order to develop manufacturing productivity, Omron will continue to offer advanced and core electronic components to the world, such as connectors suitable for industrial equipment.

\*1 Omron's original dual-spring structure ensures high contact reliability. During mating, necessary contact force is applied by the first and second springs. When removing, the lever opens the second spring, so the removal force is reduced(based on information as of November, 2020). Patent pending.

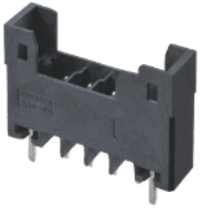
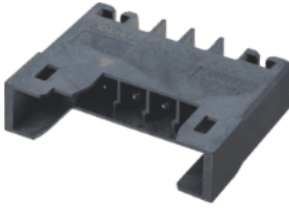
## Product Lines

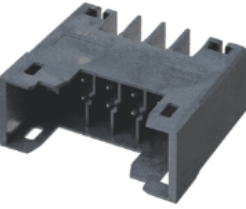
[XW4M/XW4N](#) have single row/double row types, straight/l-shape terminals, etc. Select one which meets your application.

Row	Single-row type		Double-row type	
No. of Contacts	2, 3, 4, 5, 6, 7, 8, 9, 10, 11, 12, 13, 14, 15, 16, 17, 18, 20		4, 6, 8, 10, 12, 14, 16, 18, 20, 22, 24, 26, 28, 30, 32, 34, 36, 40	
Type	Straight terminal	L-shape terminal	Straight terminal	L-shape terminal
	XW4M-□□D1-V1D□	XW4M-□□D1-H1D□	XW4M-□□D2-V1D□	XW4M-□□D2-H1D□
Plug				
Type	XW4N-□□D1-□		XW4N-□□D2-□	
Socket				

\* "□□" is replaced by the number of contacts.

\*For further information, refer to datasheets.

Figure 1 XW4M/XW4N

## Features of Push-In Terminal Blocks

Push-in method reduces wiring time, allowing user to insert wires to terminal holes.

- Wiring time can be reduced significantly

Compared to screw-terminal blocks with round/Y-shape terminals, push-in terminal blocks with ferrules can reduce 60% or more of wiring work (Figure 2).

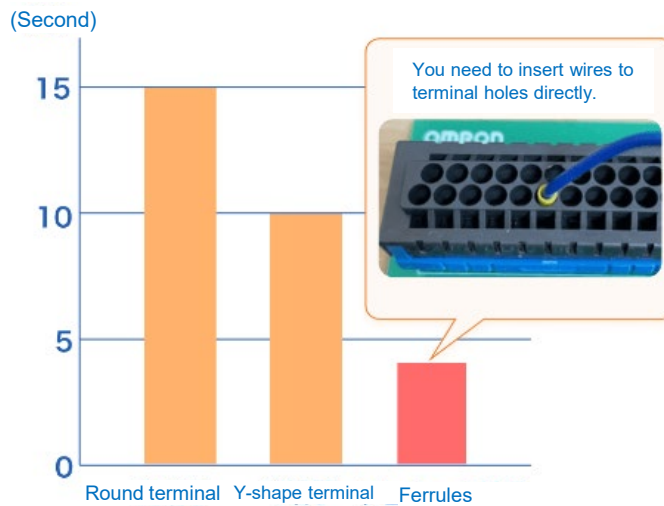

**Figure 2 Wiring time**

- No retightening required

Screw terminal blocks require a minimum of 3 screwing operations (production, shipping, and installation).

Push-in terminal have no screws, eliminating the need for screwing operations.

## XW4M/XW4N Features

### 1. Improved Workability and High Contact Reliability

With its unique dual-spring structure, the connector contact force is reduced as well as enough force is applied for mating (Figure 3).

#### During insertion and removal

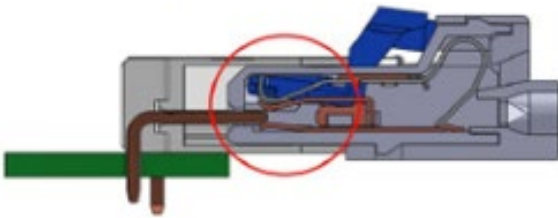

Second spring

First spring

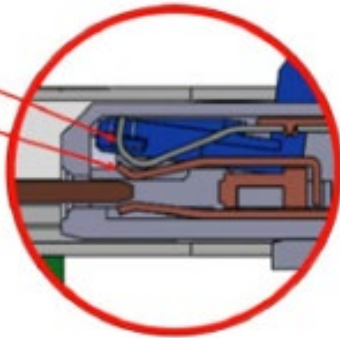

The insertion force is reduced by pressing the release lever (in blue color) to release the second spring.

#### During mating

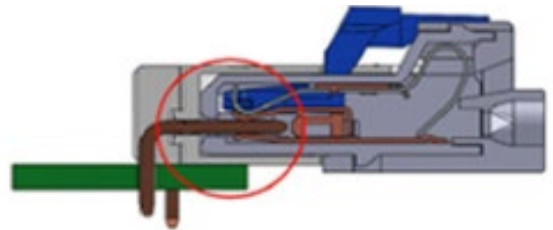

Second spring

First spring

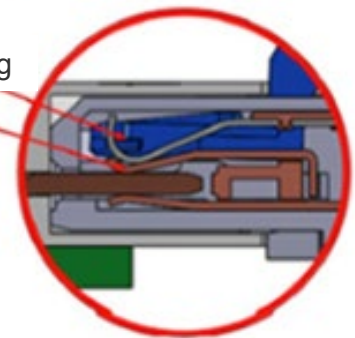

High contact reliability is achieved by the force of the second spring applied to the first spring.

Figure 3 Dual-Spring Structure

## XW4M/XW4N Features

### 2. One-Hand Insertion and Removal (Single Hand Action)

By placing the release lever in the same direction as the connector handle, the user can easily insert and remove the connector with one hand (Figure 4).

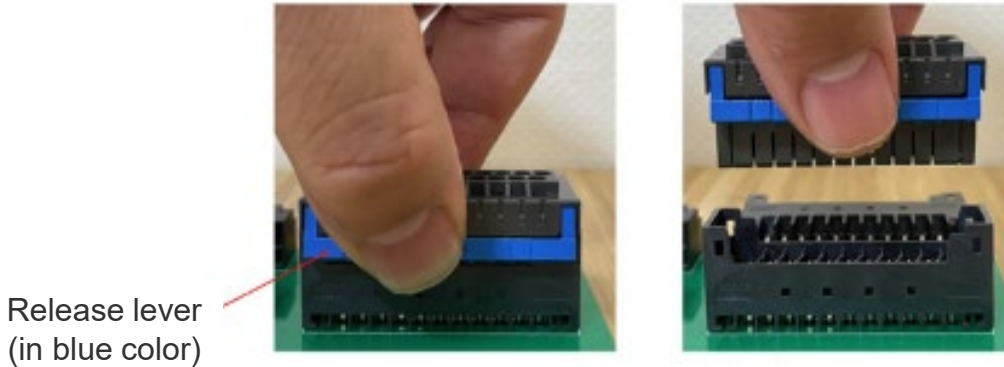

**Figure 4 Single Hand Action**

### 3. Two-Hand Work (Hands-Free Mechanism)

There are release holes that keep the screwdriver inserted so the user's hands are free for cabling (Figure 5).

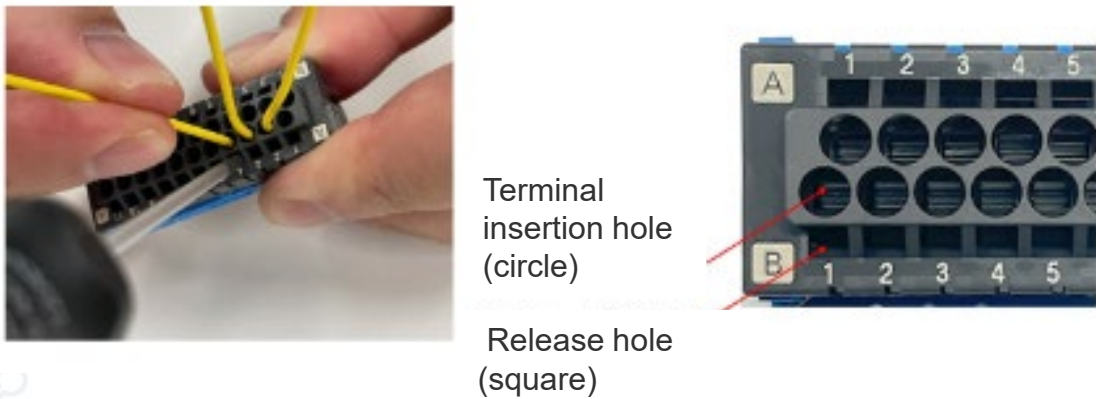
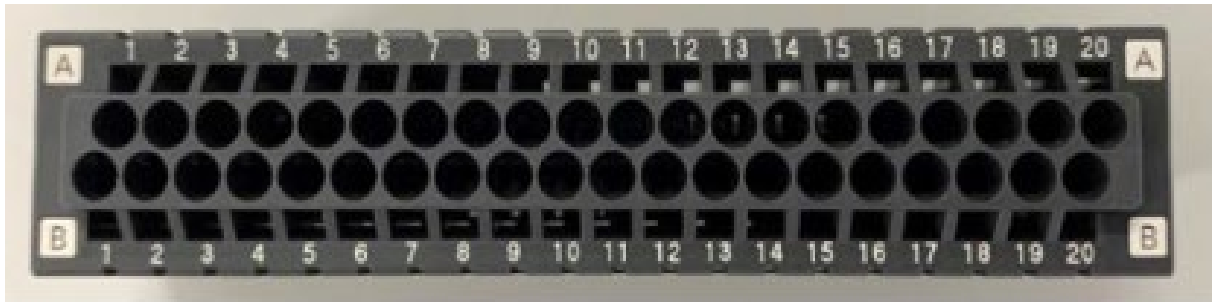

**Figure 5 Hands-Free Mechanism**

## XW4M/XW4N Features

### 4. Standard Marking of Pin Number (XW4N)

Pin numbers, which are used for cabling the connector, are labelled so the user can save space and reduce man-hours for printing the numbers on the PCB or other available space (Figure 6).



**Figure 6 Standard Marking**

### 5. Continuity Test on Wiring

A continuity test on cable connection is possible by using the release holes (Figure 7).

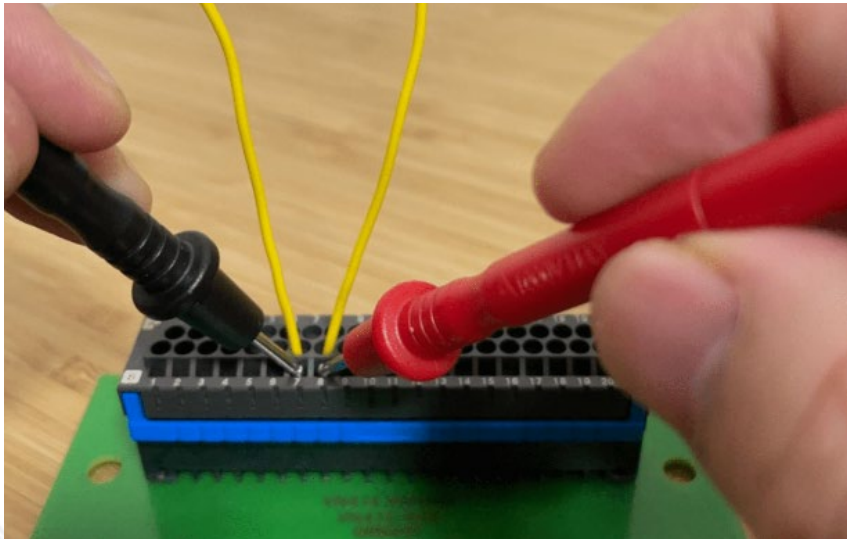

**Figure 7 Continuity Test**

Please check each region's Terms & Conditions by region website.

## OMRON Corporation

Electronic and Mechanical Components Company

### Regional Contact

#### Americas

<https://www.components.omron.com/>

#### Asia-Pacific

<https://ecb.omron.com.sg/>

#### Korea

<https://www.omron-ecb.co.kr/>

#### Europe

<http://components.omron.eu/>

#### China

<https://www.ecb.omron.com.cn/>

#### Japan

<https://www.omron.co.jp/ecb/>