

# G3VM-□WR

MOS FET Relays

P-SON 4-pin, High-Current and Low-ON-Resistance Type

## New Non-Leaded, High-Current P-SON Package

- Load voltages 30 V/60 V/100 V/200 V.
- 30 V relay: Continuous load current of 4.5 A max.
- 60 V relay: Continuous load current of 3 A max.
- 100 V relay: Continuous load current of 2 A max.
- 200 V relay: Continuous load current of 0.35 A max.
- High ambient operating temperature: -40°C to +110°C

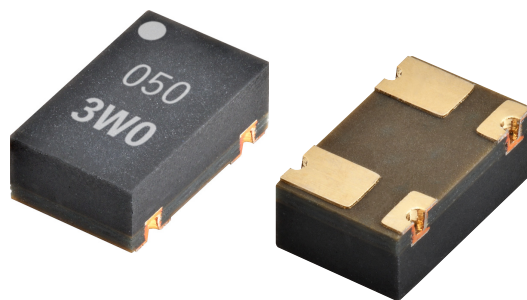

Note: The actual product is marked differently from the image shown above.

### Application Examples

- Semiconductor test equipment
- Test & measurement equipment
- Communication equipment
- Data loggers

### Package (Unit : mm, average)

P-SON 4-pin

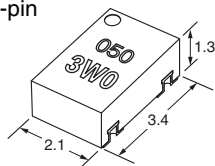

Note: The actual product is marked differently from the image shown above.

### Model Number Legend

G3VM-□□□□  
1 2 3 4

#### 1. Load voltages

- 3: 30 V
- 6: 60 V
- 10: 100 V
- 20: 200 V

#### 2. Contact form

- 1: 1a (SPST-NO)

#### 3. Package type

- W: P-SON 4-pin

#### 4. Additional function

- R: Low on-resistance

### Ordering Information

Package type	Contact form	Terminals	Load voltage (peak value) *	Continuous load current (peak value) *	Packing/Tape cut		Packing/Tape & reel	
					Model	Minimum package quantity	Model	Minimum package quantity
P-SON4	1a (SPST-NO)	Surface-mounting Terminals	30 V	4.5 A	G3VM-31WR	1 pc.	G3VM-31WR (TR05)	500 pcs.
			60 V	3 A	G3VM-61WR		G3VM-61WR (TR05)	
			100 V	2 A	G3VM-101WR		G3VM-101WR (TR05)	
			200 V	0.35 A	G3VM-201WR		G3VM-201WR (TR05)	

\* The AC peak and DC values are given for the load voltage and continuous load current.

Note: When ordering tape packing, add "(TR05)" (500 pcs/reel) to the model number.

Ask your OMRON representative for orders under 500 pcs. We can supply products with the tape already cut.

Tape-cut P-SON is packaged without humidity resistance. Use manual soldering to mount them.

Refer to common precautions.

## Absolute Maximum Ratings (Ta = 25°C)

Item		Symbol	G3VM-31WR	G3VM-61WR	G3VM-101WR	G3VM-201WR	Unit	Measurement conditions
Input	LED forward current	IF	30				mA	
	LED forward current reduction rate	ΔIF/°C	-0.3				mA/°C	Ta≥25°C
	LED reverse voltage	VR	6				V	
	Junction temperature	TJ	125				°C	
Output	Load voltage (AC peak/DC)	V <sub>OFF</sub>	30	60	100	200	V	
	Continuous load current (AC peak/DC)	I <sub>o</sub>	4.5	3	2	0.35	A	
	ON current reduction rate	ΔI <sub>o</sub> /°C	-45	-30	-20	-3.5	mA/°C	Ta≥25°C
	Pulse ON current	I <sub>op</sub>	10	9	6	1.05	A	t=100 ms, Duty=1/10
	Junction temperature	TJ	125				°C	
Dielectric strength between I/O *		V <sub>I-O</sub>	500				V <sub>rms</sub>	AC for 1 min
Ambient operating temperature		Ta	-40 to +110				°C	With no icing or condensation
Ambient storage temperature		T <sub>stg</sub>	-40 to +125				°C	
Soldering temperature		-	260				°C	10 s

Note: The product structure is sensitive to static electricity. When handling it, be sure to take measures against static electricity for the workbench, workers, soldering iron, and soldered mounted devices.

\* The dielectric strength between the input and output was checked by applying voltage between all pins as a group on the LED side and all pins as a group on the light-receiving side.

## Electrical Characteristics (Ta = 25°C)

Item		Symbol	G3VM-31WR	G3VM-61WR	G3VM-101WR	G3VM-201WR	Unit	Measurement conditions
Input	LED forward voltage	Minimum	1.1				V	I <sub>F</sub> =10 mA
		Typical	1.22					
		Maximum	1.4					
	Reverse current	I <sub>R</sub> Maximum	10				μA	V <sub>R</sub> =5 V
	Capacitance between terminals	C <sub>T</sub> Typical	70				pF	V=0 V, f=1 MHz
	Trigger LED forward current	I <sub>FT</sub>	Typical	1		0.9	1	mA
Maximum			3					
Release LED forward current	I <sub>FC</sub>	Minimum	0.1				mA	I <sub>OFF</sub> =10 μA
		Typical	0.9		0.8	0.9		
Maximum resistance with output ON	R <sub>ON</sub>	Typical	25	45	130	4,500	mΩ	I <sub>o</sub> =Continuous load current rated value I <sub>F</sub> =5 mA, t<1 s
		Maximum	50	100	200	8,000		
Current leakage when the relay is open	I <sub>LEAK</sub> Maximum		1000 (10)			10	nA	V <sub>OFF</sub> = Load voltage rated value 31WR : (V <sub>OFF</sub> =20 V) 61WR : (V <sub>OFF</sub> =40 V) 101WR : (V <sub>OFF</sub> =80 V)
Capacitance between terminals	C <sub>off</sub> Typical		450	250	170	75	pF	V=0 V, f=1 MHz
Capacitance between I/O terminals	C <sub>I-O</sub> Typical		1				pF	f=1 MHz, V <sub>s</sub> =0 V
Insulation resistance between I/O terminals	R <sub>I-O</sub> Typical		10 <sup>8</sup>				MΩ	V <sub>I-O</sub> =500 VDC, R <sub>oH</sub> ≤60%
Turn-ON time	t <sub>ON</sub>	Typical	3		2	0.5	ms	I <sub>F</sub> =5 mA, R <sub>L</sub> =200 Ω, V <sub>DD</sub> =10 V (G3VM-31WR) V <sub>DD</sub> =20 V (G3VM-61WR/101WR/201WR) *
		Maximum	5		3	1		
Turn-OFF time	t <sub>OFF</sub>	Typical	0.04		0.03	0.04	ms	*
		Maximum	1					

\* Turn-ON and Turn-OFF Times

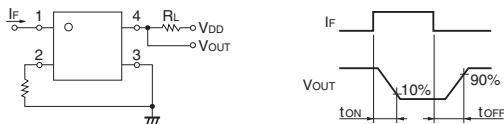

## Recommended Operating Conditions

For high reliability usage, Recommended Operation Conditions are measures that take into account the derating of Absolute Maximum Ratings and Electrical Characteristics.

Each item on this list is an independent condition, so it is not simultaneously satisfying several conditions.

Item	Symbol		G3VM-31WR	G3VM-61WR	G3VM-101WR	G3VM-201WR	Unit
Load voltage (AC peak/DC)	V <sub>DD</sub>	Maximum	24	48	80	160	V
		Typical	5				
Operating LED forward current	I <sub>F</sub>	Maximum	20				mA
		Typical	5				
Continuous load current (AC peak/DC)	I <sub>o</sub>	Maximum	4.5	3	2	0.35	A
Ambient operating temperature	Ta	Minimum	-20				°C
		Maximum	85				

## Engineering Data

### LED forward current vs. ambient temperature

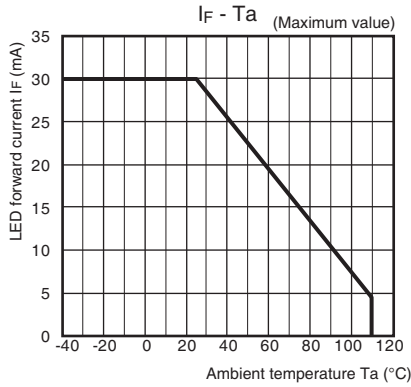

### Continuous load current vs. ambient temperature

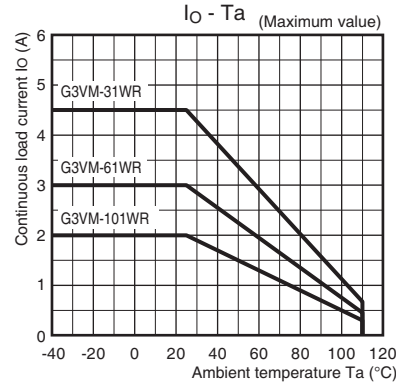

### G3VM-201WR

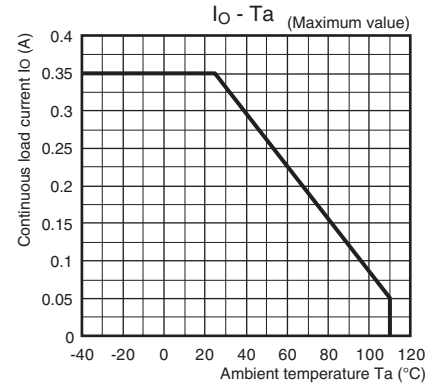

### LED forward current vs. LED forward voltage

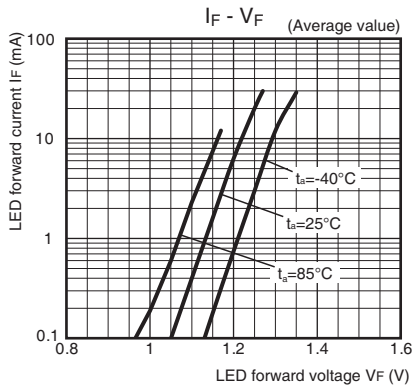

### Continuous load current vs. on-state voltage

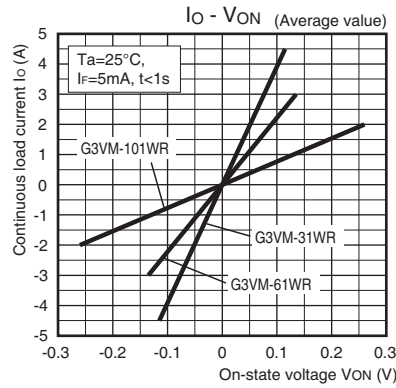

### G3VM-201WR

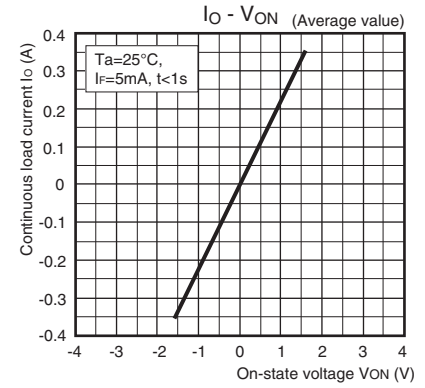

### On-state resistance vs. ambient temperature

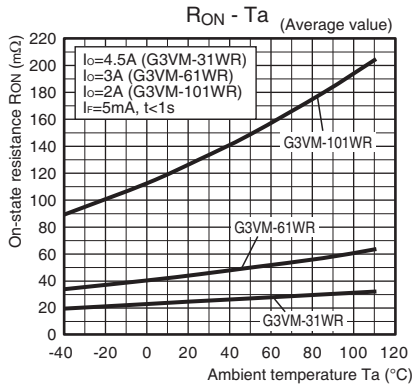

### G3VM-201WR

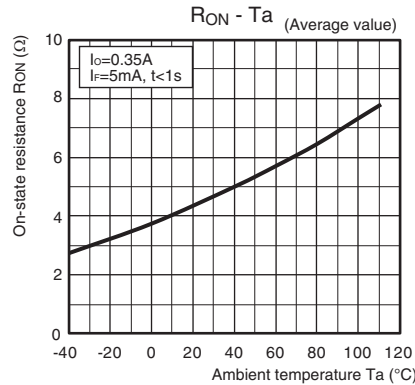

### Trigger LED forward current vs. ambient temperature

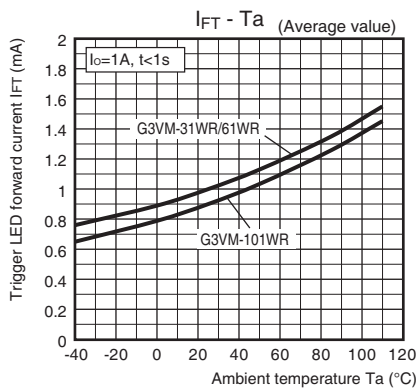

### G3VM-201WR

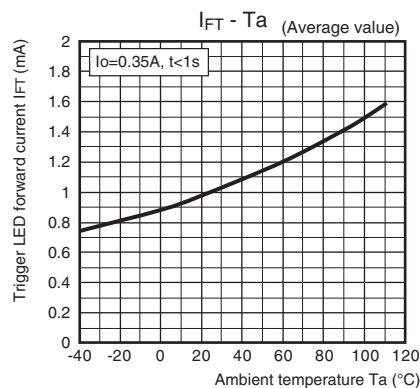

## Engineering Data

### Turn ON, turn OFF time vs. LED forward current LED forward current G3VM-31WR/61WR/101WR

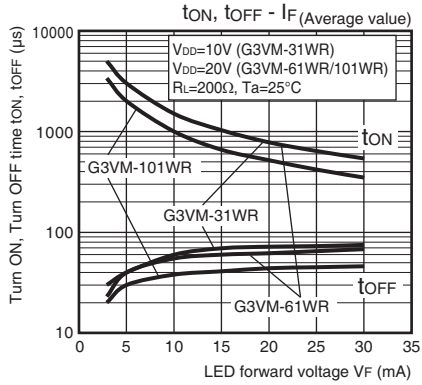

### G3VM-201WR

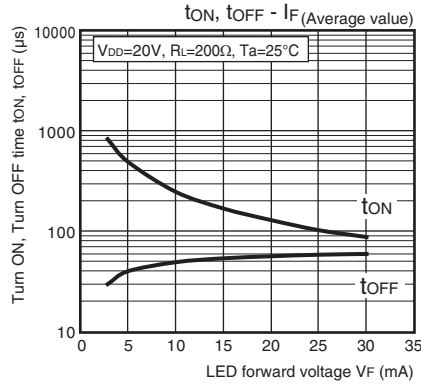

### Turn ON, turn OFF time vs. ambient temperature ambient temperature G3VM-31WR/61WR/101WR

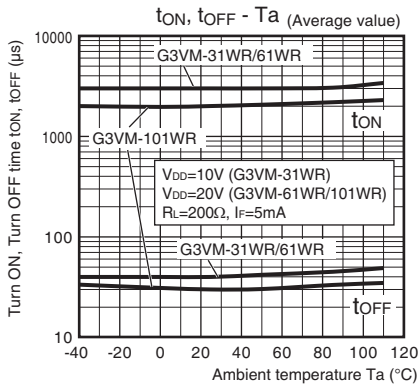

### G3VM-201WR

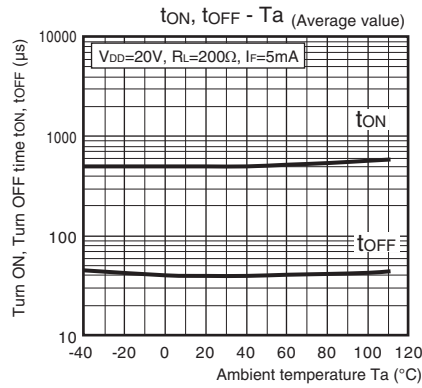

### Current leakage vs. load voltage load voltage G3VM-31WR/61WR/101WR

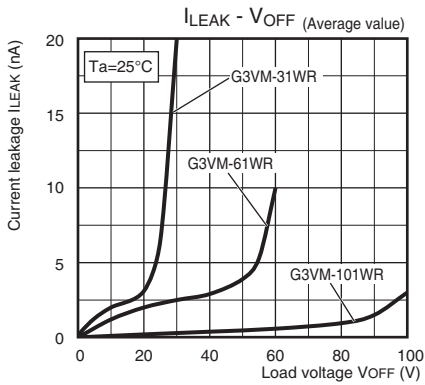

### G3VM-201WR

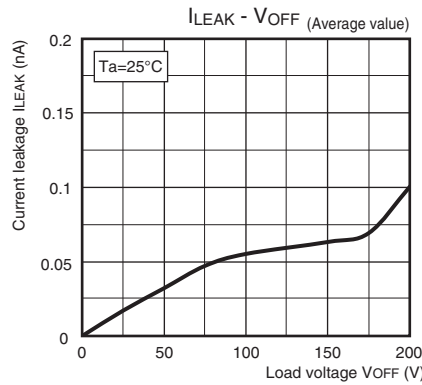

### Current leakage vs. ambient temperature ambient temperature

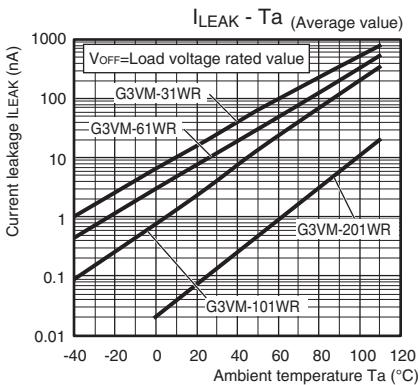

### Output terminal capacitance vs. load voltage load voltage

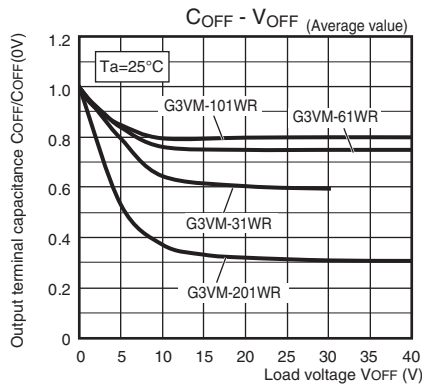

## Appearance / Terminal Arrangement / Internal Connections

### Appearance

P-SON (Power - Small Outline Non-Leaded)  
P-SON 4-pin

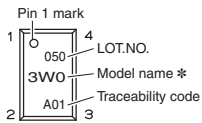

\* Actual model name marking for each model

Model	Marking
G3VM-31WR	3W0
G3VM-61WR	6W0
G3VM-101WR	AW0
G3VM-201WR	BW0

### Terminal Arrangement/Internal Connections (Top View)

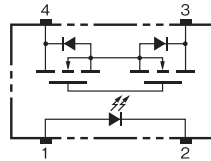

**Note 1.** The actual product is marked differently from the image shown above.  
**2.** "G3VM" does not appear in the model number on the relay.

### Dimensions (Unit: mm)

#### Surface-Mounting Terminals

Weight: 0.02 g

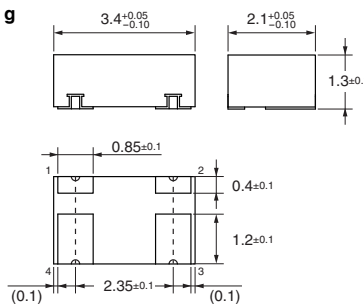
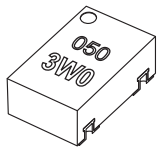

#### Actual Mounting Pad Dimensions

(Recommended Value, Top View)

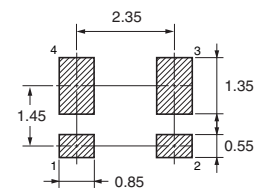

Unless otherwise specified, the dimensional tolerance is ± 0.1 mm.

**Note:** The actual product is marked differently from the image shown here.

### Safety Precautions

- Refer to "Common Precautions" for all G3VM models.

Please check each region's Terms & Conditions by region website.

**OMRON Corporation**  
Device & Module Solutions Company

#### Regional Contact

##### Americas

<https://components.omron.com/us>

##### Asia-Pacific

<https://components.omron.com/ap>

##### Korea

<https://components.omron.com/kr>

##### Europe

<https://components.omron.com/eu>

##### China

<https://components.omron.com.cn>

##### Japan

<https://components.omron.com/jp>