

# G3VM-□BY/□EY

MOS FET Relays DIP 6-pin, High-dielectric-strength Type

## MOS FET Relays in DIP 6-pin packages that achieve a dielectric strength of 5,000 VAC between I/O

• Load voltage: 400 V or 600 V

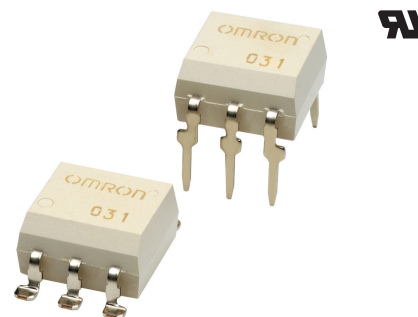

Note: The actual product is marked differently from the image shown here.

### Application Examples

- Electrical power unit
- Industrial equipment
- Test & Measurement equipment
- Medical equipment
- Security equipment

### Package

(Unit : mm, Average)

DIP 6-pin  
PCB Terminals

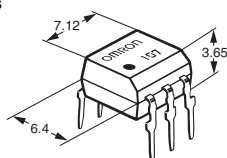

Surface-mounting Terminals

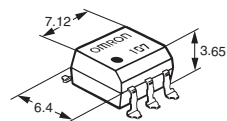

Note: The actual product is marked differently from the image shown here.

### Model Number Legend

G3VM-□□□□□  
1 2 3 4 5

- Load Voltage**  
40 : 400 V  
60 : 600 V
- Contact form**  
1 : 1a (SPST-NO)
- Package**  
B : DIP 6-pin with PCB terminals  
E : DIP 6-pin with surface-mounting terminals
- Additional functions**  
Y : Dielectric strength between I/O above 2,500 V type
- Other informations**  
When specifications overlap, serial code is added in the recorded order.

### Ordering Information

Package	Contact form	Load voltage (peak value) *	Continuous load current (peak value) *		Stick packaging			Tape packaging	
			Connection A, B	Connection C	Model		Minimum package quantity	Model	Minimum package quantity
					PCB Terminals	Surface-mounting Terminals			
DIP6	1a (SPST-NO)	400 V	120 mA	240 mA	G3VM-401BY	G3VM-401EY	50 pcs.	G3VM-401EY(TR)	1,500 pcs.
		600 V	100 mA	200 mA	G3VM-601BY	G3VM-601EY		G3VM-601EY(TR)	

\* The AC peak and DC value are given for the load voltage and continuous load current.

Note: To order tape packaging for Relays with surface-mounting terminals, add "(TR)" to the end of the model number.

### Absolute Maximum Ratings (Ta = 25°C)

Item		Symbol	G3VM-401BY G3VM-401EY	G3VM-601BY G3VM-601EY	Unit	Measurement conditions	
Input	LED forward current	IF	50		mA		
	Repetitive peak LED forward current	IFP	1		A	100 μs pulses, 100 pps	
	LED forward current reduction rate	ΔIF/°C	-0.5		mA/°C	Ta ≥ 25°C	
	LED reverse voltage	VR	5		V		
	Connection temperature	TJ	125		°C		
Output	Load voltage (AC peak/DC)	V <sub>OFF</sub>	400	600	V		
	Continuous load current	Connection A	I <sub>o</sub>	120	100	mA	Connection A: AC peak/DC Connection B and C: DC
		Connection B					
		Connection C		240	200		
	ON current reduction rate	Connection A	ΔI <sub>o</sub> /°C	-1.2	-1.0	mA/°C	Ta ≥ 25°C
Connection B							
Connection C		-2.4					
Connection temperature	TJ	125		°C			
Dielectric strength between I/O *		V <sub>I-O</sub>	5000		V <sub>rms</sub>	AC for 1 min	
Ambient operating temperature		Ta	-40 to +85		°C	With no icing or condensation	
Ambient storage temperature		Tstg	-55 to +125		°C		
Soldering temperature		-	260		°C	10 s	

\* The dielectric strength between the input and output was checked by applying voltage between all pins as a group on the LED side and all pins as a group on the light-receiving side.

#### Connection Diagram

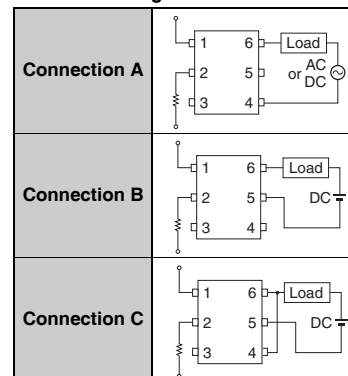

## ■Electrical Characteristics (Ta = 25°C)

Item		Symbol		G3VM-401BY G3VM-401EY	G3VM-601BY G3VM-601EY	Unit	Measurement conditions	
Input	LED forward voltage	VF	Minimum	1		V	IF=10 mA	
			Typical	1.15				
			Maximum	1.3				
	Reverse current	IR	Maximum	10		μA	VR=5 V	
Capacitance between terminals		CT	Typical	30		pF	V=0, f=1 MHz	
Trigger LED forward current	IFT		Typical	-	1.6	mA	Io=Continuous load current ratings	
			Maximum	3	5			
Output	Maximum resistance with output ON	RON	Typical	Connection A	17	30 (25)	Ω	G3VM-401BY/EY : IF= 5 mA, Io=120 mA G3VM-601BY/EY : IF=10 mA, Io=100 mA Values in parentheses are for t < 1 s. G3VM-401BY/EY : IF= 5 mA, Io=120 mA G3VM-601BY/EY : IF=10 mA, Io=100 mA G3VM-401BY/EY : IF= 5 mA, Io=240 mA G3VM-601BY/EY : IF=10 mA, Io=200 mA G3VM-401BY/EY : IF= 5 mA, Io=120 mA G3VM-601BY/EY : IF=10 mA, Io=100 mA Values in parentheses are for t < 1 s. G3VM-401BY/EY : IF= 5 mA, Io=120 mA G3VM-601BY/EY : IF=10 mA, Io=100 mA G3VM-401BY/EY : IF= 5 mA, Io=240 mA G3VM-601BY/EY : IF=10 mA, Io=200 mA
				Connection B	11	23		
				Connection C	6	12		
			Maximum	Connection A	35	45 (35)		
				Connection B	20	35		
				Connection C	10	18		
	Current leakage when the relay is open		I <sub>LEAK</sub>	Maximum	1		μA	V <sub>OFF</sub> =Load voltage ratings
	Capacitance between terminals		C <sub>OFF</sub>	Typical	40	120	pF	V=0, f=1 MHz
	Capacitance between I/O terminals		C <sub>I-O</sub>	Typical	0.8		pF	f=1 MHz, Vs=0 V
	Insulation resistance between I/O terminals		R <sub>I-O</sub>	Minimum	1000		MΩ	V <sub>I-O</sub> =500 VDC, RoH≤60%
Typical				10 <sup>8</sup>				
Turn-ON time		t <sub>ON</sub>	Typical	0.3	0.2	ms	G3VM-401BY/EY : IF=5mA, RL=200Ω, V <sub>DD</sub> =20V * G3VM-601BY/EY : IF=10mA, RL=200Ω, V <sub>DD</sub> =20V *	
Turn-OFF time			t <sub>OFF</sub>	Typical	0.1			0.2
				Maximum	1.0			

\* Turn-ON and Turn-OFF Times

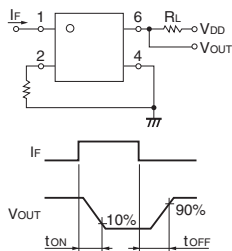

## ■Recommended Operating Conditions

For usage with high reliability, Recommended Operation Conditions is a measure that takes into account the derating of Absolute Maximum Ratings and Electrical Characteristics.

Each item on this list is an independent condition, so it is not simultaneously satisfy several conditions.

Item	Symbol		G3VM-401BY G3VM-401EY	G3VM-601BY G3VM-601EY	Unit
Load voltage (AC peak/DC)	V <sub>DD</sub>	Maximum	320	480	V
		Minimum	5	7.5	
Operating LED forward current	IF	Typical	7.5	15	mA
		Maximum	25		
		Maximum	120	100	
Ambient operating temperature	Ta	Minimum	-20		°C
		Maximum	65		

## ■Spacing and Insulation

Item	Minimum	Unit
Creepage distances	7.0	mm
Clearance distances	7.0	
Internal isolation thickness	0.4	

## Engineering Data

### LED forward current vs. Ambient temperature

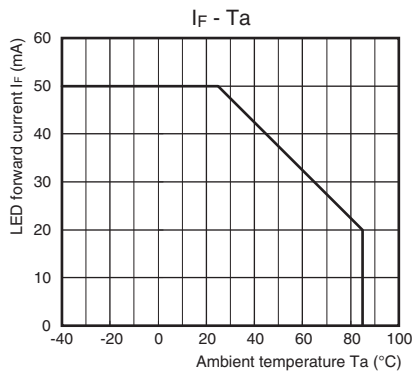

### Continuous load current vs. Ambient temperature

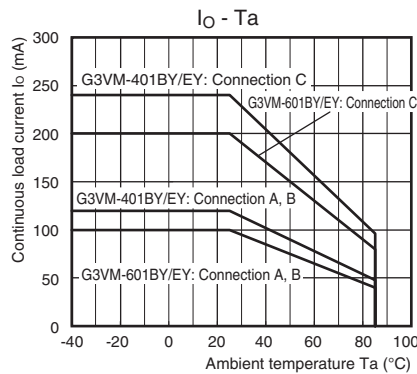

### LED forward current vs. LED forward voltage

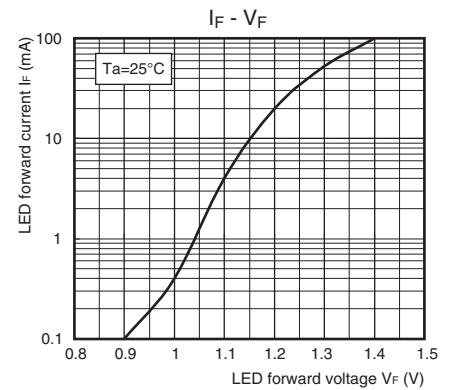

### Continuous load current vs. On-state voltage

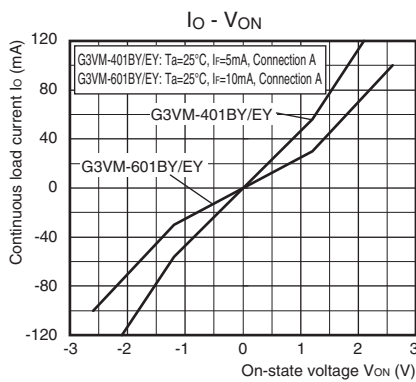

### On-state resistance vs. Ambient temperature

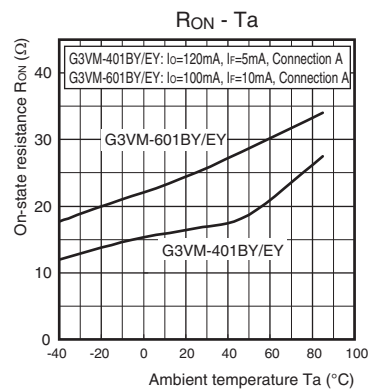

### Trigger LED forward current vs. Ambient temperature

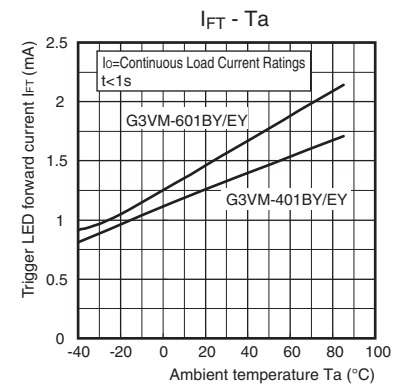

### Turn ON, Turn OFF time vs. LED forward current

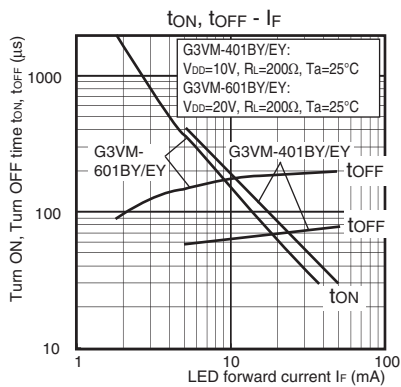

### Turn ON, Turn OFF time vs. Ambient temperature

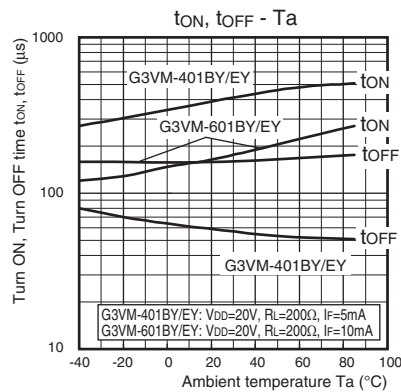

### Current leakage vs. Ambient temperature

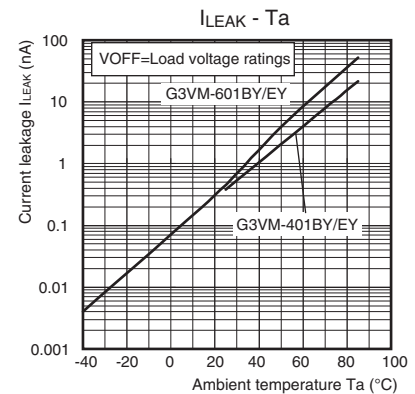

## ■ Appearance / Terminal Arrangement / Internal Connections

### ● Appearance

#### DIP (Dual Inline Package)

DIP 6-pin

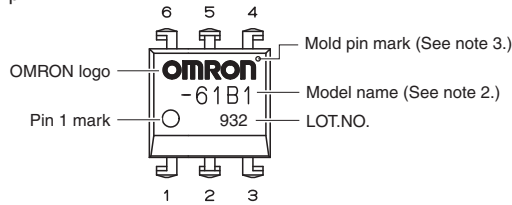

- Note 1.** The actual product is marked differently from the image shown here.
- Note 2.** "G3VM" does not appear in the model number on the Relay.
- Note 3.** The indentation in the corner diagonally opposite from the pin 1 mark is from a pin on the mold.

### ● Terminal Arrangement/Internal Connections (Top View)

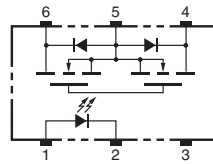

### ■ Dimensions (Unit: mm)

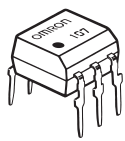

#### PCB Terminals

Weight: 0.4 g

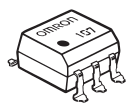
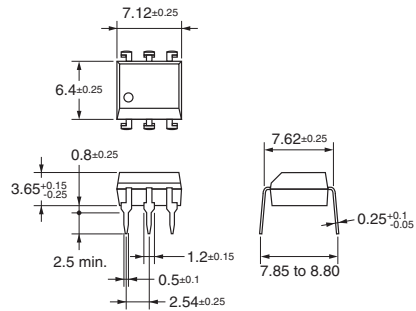

#### Surface-mounting Terminals

Weight: 0.4 g

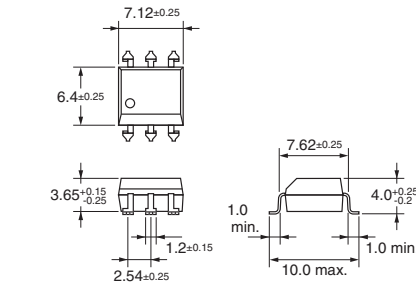

#### PCB Dimensions (BOTTOM VIEW)

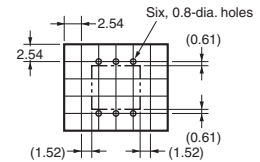

#### Actual Mounting Pad Dimensions

(Recommended Value, Top View)

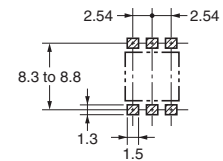

**Note:** The actual product is marked differently from the image shown here.

### ■ Approved Standards

UL recognized

Approved Standards	Contact form	File No.
UL (recognized)	1a (SPST-NO)	E80555

### ■ Safety Precautions

- Refer to the *Common Precautions for All MOS FET Relays* for precautions that apply to all MOS FET Relays.

Please check each region's Terms & Conditions by region website.

## OMRON Corporation

Device & Module Solutions Company

### Regional Contact

#### Americas

<https://components.omron.com/us>

#### Asia-Pacific

<https://components.omron.com/ap>

#### Korea

<https://components.omron.com/kr>

#### Europe

<https://components.omron.com/eu>

#### China

<https://components.omron.com.cn>

#### Japan

<https://components.omron.com/jp>