

# D2LS

Ultra Subminiature Basic Switch

## Compact Surface-mounting Switches ideal for applications requiring long durability High Force type also available

- High operating force type also achieving long durability (OF: 1.2 N, Durability: 5,000,000 operations)
- Compact size 8.6 × 4.8 × 3.0 mm (W × D × H) contributing to down-sizing of module
- Clear click feeling
- Embossed taping package for automatic mounting

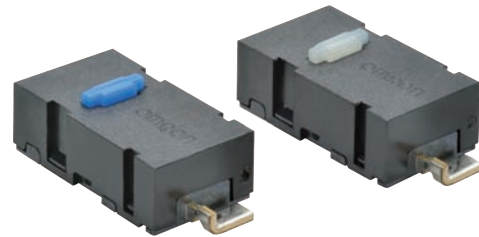

**NEW**

RoHS Compliant

### Model Number Legend

D2LS-□ 1

Operating Force (OF)

1: 1.2±0.4 N {122±41 gf}

2: 0.6±0.2 N {61±20 gf}

### Contact Form

- SPST-NO

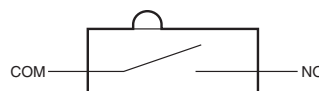

### List of Models

Operating Force (OF)	Button color	Model	Minimum packing unit *
1.2 N {122 gf}	WHITE	D2LS-11	2,000 pcs.
0.6 N {61 gf}	BLUE	D2LS-21	

\* Products are packed with embossed tape.

### Contact Specifications

Contact	Specification	Crossbar
	Material	Silver
	Gap (standard value)	0.4 mm
Minimum applicable load (reference value)		3 VDC 15 μA

### Ratings

Rated voltage	Resistive load
6 VDC	1 mA

Note: The rating values apply under the following test conditions.

Ambient temperature: 20 ± 2°C

Ambient humidity: 65 ± 5%RH

Operating frequency: 30 operations/min

### Characteristics

Operating speed		1 mm to 500 mm/s
Operating frequency	Mechanical/Electrical	300 operations/min max.
Insulation resistance		100 MΩ min. (at 500 VDC)
Contact resistance (initial value)		100 mΩ max.
Dielectric strength	Between terminals of same polarity	600 VAC 50/60 Hz 1 min
Vibration resistance *1	Malfunction	10 to 55 Hz, 1.5 mm double amplitude
	Destruction	1,000 m/s <sup>2</sup> max.
Shock resistance *1	Malfunction	300 m/s <sup>2</sup> max.
	Destruction	
Durability *2	Mechanical/Electrical	5,000,000 operations min. (at 300 ops./min.)
Degree of protection		IP40
Ambient operating temperature		-25 to +85°C (at 60%RH Max.) (with no icing or condensation)
Ambient operation humidity		85%RH max. (for +5 to +35°C)
Weight		Approx. 0.16 g

Note: The data given above are initial values.

\*1. The values are at Free Position and Total Travel Position values.

Close or open circuit of the contact is 1ms max.

\*2. For testing conditions, consult your OMRON sales representative.

## Dimensions (Unit: mm) / Operating Characteristics

D2LS-11  
D2LS-21

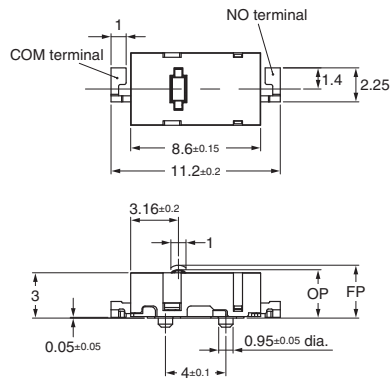
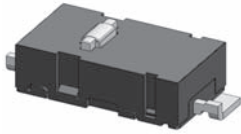

PCB pad dimensions (reference)  
(TOP VIEW)

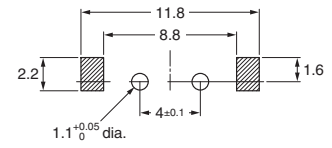

Model		D2LS-11	D2LS-21
<b>Operating Characteristics</b>			
<b>Operating Force</b>	OF	1.2 ± 0.4 N {122 ± 41 gf}	0.6 ± 0.2 N {61 ± 20 gf}
<b>Releasing Force</b>	RF min.	0.15 N {15 gf}	0.15 N {15 gf}
<b>Overtravel</b>	OT min.	0.1 mm	
<b>Movement Differential</b>	MD max.	0.12 mm	
<b>Operating Position</b>	OP	3.2 ± 0.2 mm	
<b>Free Position</b>	FP	3.5 ± 0.2 mm	

Note: Unless otherwise specified, a tolerance of ±0.4 mm applies to all dimensions.

## Packaging Specifications (Unit: mm)

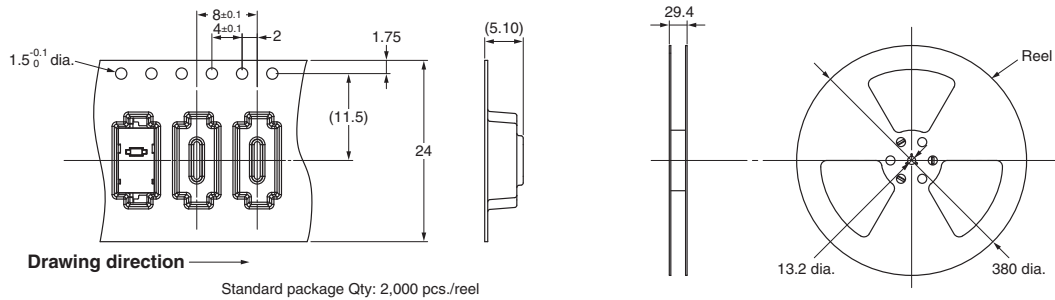

## Precautions

★ Refer to General Information.

### Cautions

Use the Switch within the rated voltage and current ranges, otherwise the Switch may have a shortened durability, radiate heat, or burn out. This particularly applies to the instantaneous voltages and currents when switching.

### Correct Use

#### ● Soldering

##### • General Precautions

Before soldering the Switch on a multilayer PCB, test to confirm that soldering can be performed properly. Otherwise the Switch may be deformed by the soldering heat on the pattern or lands of the multilayer PCB.

Do not solder the Switch more than twice, including rectification soldering. An interval of five minutes is required between the first and the second soldering.

##### • Reflow Soldering (Surface Mounting)

Solder the terminals within the heating curve shown in the following diagram.

The peak temperature may vary depending on the reflow bath used. Confirm the conditions beforehand.

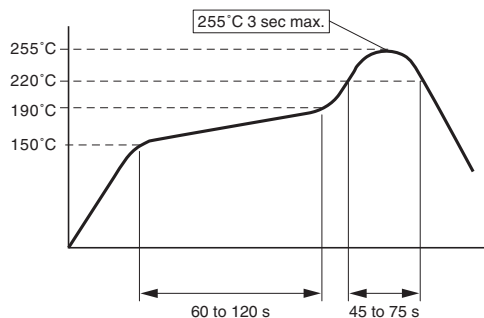

##### • Manual Soldering

Soldering temperature: 350°C max. at the tip of the soldering iron

Soldering time: 3 s max.

##### ● Washing

The Switch is not sealed, and cannot be washed. Doing so will cause the washing agent, together with flux or dust particles on the PCB, to enter the Switch, resulting in malfunction.

##### ● Application Environment

Do not use the Switch in locations that are subject to toxic gas, silicon, excessive dust, excessive dirt, high temperatures, high humidity, sudden temperature changes, water splashes, or oil splashes.

Otherwise, damage resulting by faulty contact of the Switch contacts, corrosion, or other causes, or other functional faults may occur.

• Application examples provided in this document are for reference only. In actual applications, confirm equipment functions and safety before using the product.  
 • Consult your OMRON representative before using the product under conditions which are not described in the manual or applying the product to nuclear control systems, railroad systems, aviation systems, vehicles, combustion systems, medical equipment, amusement machines, safety equipment, and other systems or equipment that may have a serious influence on lives and property if used improperly. Make sure that the ratings and performance characteristics of the product provide a margin of safety for the system or equipment, and be sure to provide the system or equipment with double safety mechanisms.

**Note: Do not use this document to operate the Unit.**