

# Photomicrosensor (Transmissive)

# EE-SX198

## Slot Type (Slot Width: 3 mm)

- Terminal for PCB mounting
- An all-purpose type that is easy to design

 Be sure to read *Safety Precautions* on Page 3.

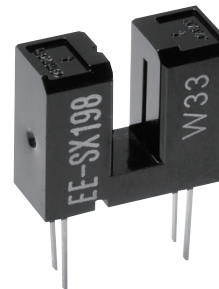

## Ordering Information

### Photomicrosensor

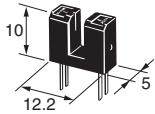
Appearance	Sensing method	Connecting method	Sensing distance	Aperture size (H x W) (mm)	Output type	Model	Minimum packing unit (Unit: pcs)
	Transmissive (slot type)	Terminal for PCB mounting	3 mm (Slot width)	Both emitting side and detecting side 2 x 0.5	Phototransistor	EE-SX198	1

Note: Order in multiples of minimum packing unit.

## Ratings, Characteristics and Exterior Specifications

### Absolute Maximum Ratings (Ta = 25°C)

Item	Symbol	Rated value	Unit
<b>Emitter</b>			
Forward current	I <sub>F</sub>	50*1	mA
Pulse forward current	I <sub>FP</sub>	1*2	A
Reverse voltage	V <sub>R</sub>	4	V
<b>Detector</b>			
Collector-Emitter voltage	V <sub>CEO</sub>	30	V
Emitter-Collector voltage	V <sub>ECO</sub>	—	V
Collector current	I <sub>C</sub>	20	mA
Collector dissipation	P <sub>C</sub>	100*1	mW
Operating temperature	T <sub>opr</sub>	-25 to 85	°C
Storage temperature	T <sub>stg</sub>	-30 to 100	°C
Soldering temperature	T <sub>sol</sub>	260*3	°C

\*1. Refer to the temperature rating chart if the ambient temperature exceeds 25°C.

\*2. Pulse width ≤ 10 μs, Repeated 100 Hz

\*3. Complete soldering within 10 seconds.

### Exterior Specifications

Connecting method	Weight (g)	Material
		Case
Terminal for PCB mounting	0.5	Polycarbonate

### Electrical and Optical Characteristics (Ta = 25°C)

Item	Symbol	Value			Unit	Condition
		MIN.	TYP.	MAX.		
<b>Emitter</b>						
Forward voltage	V <sub>F</sub>	—	1.2	1.4	V	I <sub>F</sub> = 30 mA
Reverse current	I <sub>R</sub>	—	0.01	10	μA	V <sub>R</sub> = 4 V
Peak emission wavelength	λ <sub>P</sub>	—	940	—	nm	I <sub>F</sub> = 20 mA
<b>Detector</b>						
Light current	I <sub>L</sub>	0.5	—	14	mA	I <sub>F</sub> = 20 mA, V <sub>CE</sub> = 5 V
Dark current	I <sub>D</sub>	—	2	200	nA	V <sub>CE</sub> = 20 V, 0 lx
Leakage current	I <sub>LEAK</sub>	—	—	—	μA	—
Collector-Emitter saturated voltage	V <sub>CE (sat)</sub>	—	0.1	0.4	V	I <sub>F</sub> = 40 mA, I <sub>L</sub> = 0.5 mA
Peak spectral sensitivity wavelength	λ <sub>P</sub>	—	850	—	nm	V <sub>CE</sub> = 10 V
Rising time	t <sub>r</sub>	—	4	—	μs	V <sub>CC</sub> = 5 V, R <sub>L</sub> = 100 Ω, I <sub>L</sub> = 5 mA
Falling time	t <sub>f</sub>	—	4	—	μs	V <sub>CC</sub> = 5 V, R <sub>L</sub> = 100 Ω, I <sub>L</sub> = 5 mA

# Engineering Data (Reference Value)

**Fig 1. Forward Current vs. Collector Dissipation Temperature Rating**

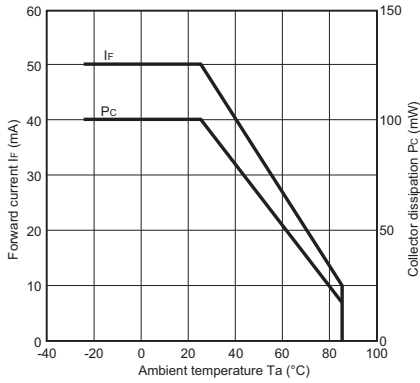

**Fig 2. Forward Current vs. Forward Voltage Characteristics (Typical)**

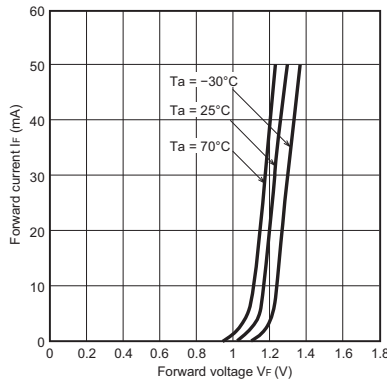

**Fig 3. Light Current vs. Forward Current Characteristics (Typical)**

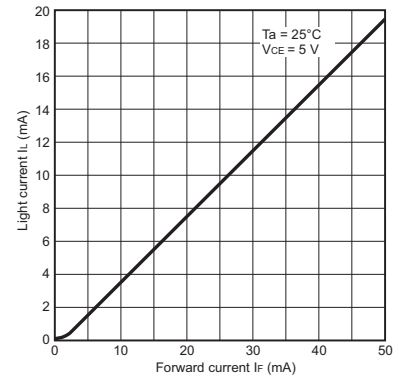

**Fig 4. Light Current vs. Collector-Emitter Voltage Characteristics (Typical)**

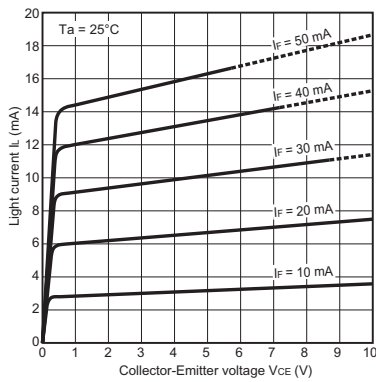

**Fig 5. Relative Light Current vs. Ambient Temperature Characteristics (Typical)**

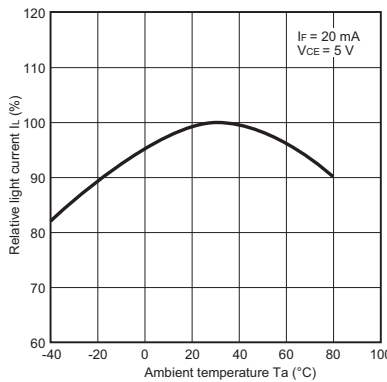

**Fig 6. Dark Current vs. Ambient Temperature Characteristics (Typical)**

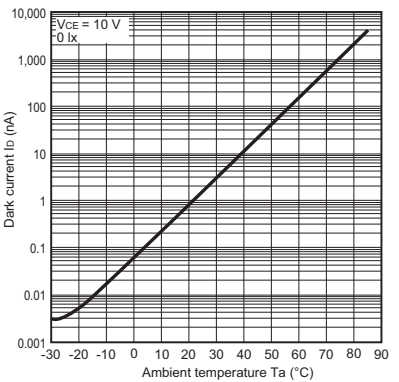

**Fig 7. Response Time vs. Load Resistance Characteristics (Typical)**

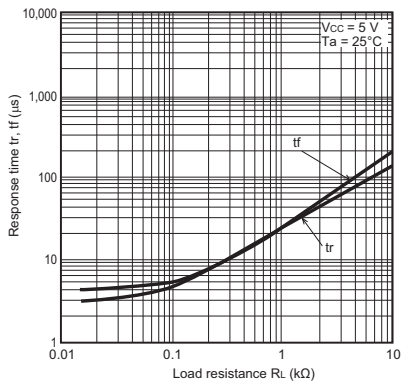

**Fig 8. Sensing Position Characteristics (Typical)**

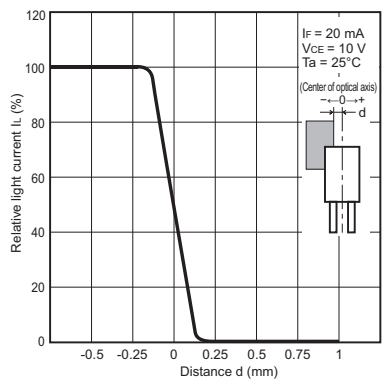

**Fig 9. Sensing Position Characteristics (Typical)**

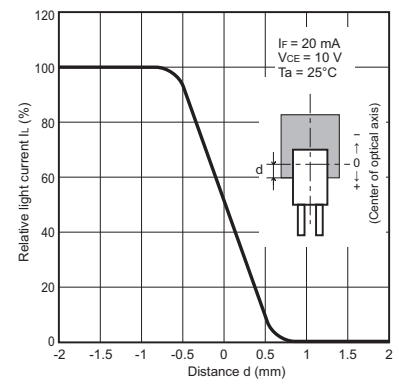

**Fig 10. Response Time Measurement Circuit**

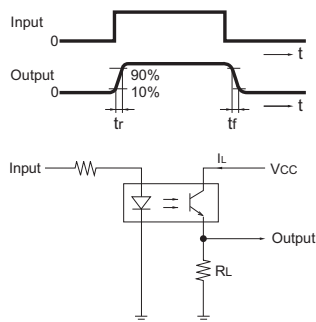

## Safety Precautions

To ensure safe operation, be sure to read and follow the Instruction Manual provided with the Sensor.

**⚠ CAUTION**

This product is not designed or rated for ensuring safety of persons either directly or indirectly. Do not use it for such purposes.



**Precautions for Correct Use**

Do not use the product in atmospheres or environments that exceed product ratings.

**Precautions for Safe Use**

**Do not use the product with a voltage or current that exceeds the rated range.**

Applying a voltage or current that is higher than the rated range may result in explosion or fire.

**Do not miswire such as the polarity of the power supply voltage.**

Otherwise the product may be damaged or it may burn.

**This product does not resist water. Do not use the product in places where water or oil may be sprayed onto the product.**

## Dimensions and Internal Circuit

(Unit: mm)

### Photomicrosensor

EE-SX198

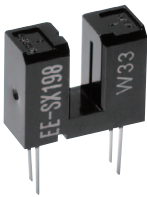

Aperture size

Emitter	Detector
2 × 0.5	2 × 0.5

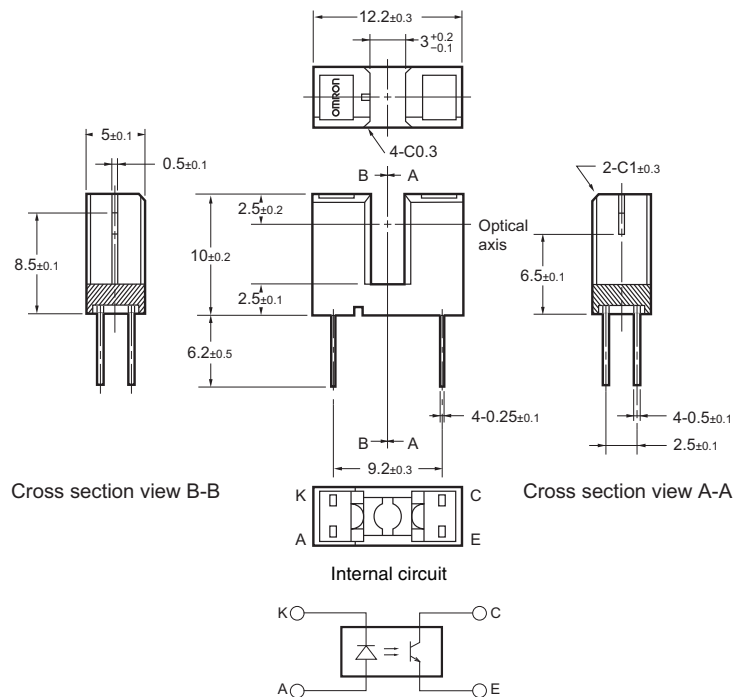

Terminal No.	Name
A	Anode
K	Cathode
C	Collector
E	Emitter

Unless otherwise specified, the tolerances are ±0.2 mm.

Please check each region's Terms & Conditions by region website.

---

## **OMRON Corporation**

**Device & Module Solutions Company**

### **Regional Contact**

#### **Americas**

<https://components.omron.com/us>

#### **Asia-Pacific**

<https://components.omron.com/ap>

#### **Korea**

<https://components.omron.com/kr>

#### **Europe**

<https://components.omron.com/eu>

#### **China**

<https://components.omron.com.cn>

#### **Japan**

<https://components.omron.com/jp>