

G3VM-63BR/63ER

MOS FET Relays DIP 6-pin, High Current and Low ON-Resistance Type

MOS FET Relays in DIP 6-pin Packages with SPST-NC Contacts That Achieve Low ON-Resistance and High Switching Capacity of a Mechanical Relay

- Contact form: 1b
 - Load voltage: 60 V
 - Continuous load current (peak value): 1.2 A (2.4 A) *
- * Values in parentheses are for connection C.



Note: The actual product is marked differently from the image shown here.

Application Examples

- Industrial equipment (PLC, Temperature controller, Power supply, etc.)
- Security equipment
- Test & measurement equipment
- Communication equipment

Package (Unit : mm, average)

DIP 6-pin
PCB Terminals

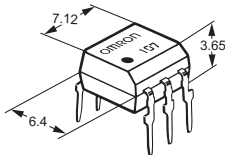

Surface-mounting Terminals

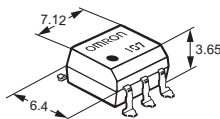

Note: The actual product is marked differently from the image shown here.

Model Number Legend

G3VM-□ □ □ □
1 2 3 4

- 1. Load voltage**
6 : 60 V
- 2. Contact form**
3 : 1b (SPST-NC)
- 3. Package**
B : DIP 6-pin with PCB terminals
E : DIP 6-pin with surface-mounting terminals
- 4. Additional functions**
R : Low ON resistance

Ordering Information

Package	Contact form	Load voltage (peak value) *	Continuous load current (peak value) *		Stick packaging			Tape packaging	
					Model		Minimum package quantity	Model	
					Connection A, B	Connection C		PCB terminals	Surface-mounting terminals
DIP6	1b	60 V	1.2 A	2.4 A	G3VM-63BR	G3VM-63ER	50 pcs.	G3VM-63ER(TR05)	500 pcs.

* The AC peak and DC value are given for the load voltage and continuous load current.

Note: To order tape packaging for relays with surface-mounting terminals, add "(TR05)" to the end of the model number.

G3VM-63BR/63ER

Absolute Maximum Ratings (Ta = 25°C)

Item		Symbol	G3VM-63BR G3VM-63ER	Unit	Measurement conditions	
Input	LED forward current	I_F	20	mA		
	LED forward current reduction rate	$\Delta I_F/^\circ\text{C}$	-0.3	mA/°C	Ta ≥ 58°C	
	LED reverse voltage	V_R	6	V		
	Junction temperature	T_J	125	°C		
Output	Load voltage (AC peak/DC)	V_{OFF}	60	V		
	Continuous load current	Connection A	I_o	1.2	A	Connection A: AC peak/DC Connection B and C: DC
		Connection B		2.4		
		Connection C				
	ON current reduction rate	Connection A	$\Delta I_o/^\circ\text{C}$	-12	mA/°C	Ta ≥ 25°C
		Connection B		-24		
		Connection C				
	Pulse ON current	I_{op}	3	A	t=100 ms, Duty=1/10	
Junction temperature	T_J	125	°C			
Dielectric strength between I/O *		V_{I-O}	5,000	Vrms	AC for 1 min	
Ambient operating temperature		Ta	-40 to +110	°C	With no icing or condensation	
Ambient storage temperature		Tstg	-55 to +125	°C		
Soldering temperature		—	260	°C	10 s	

* The dielectric strength between the input and output was checked by applying voltage between all pins as a group on the LED side and all pins as a group on the light-receiving side.

Connection Diagram

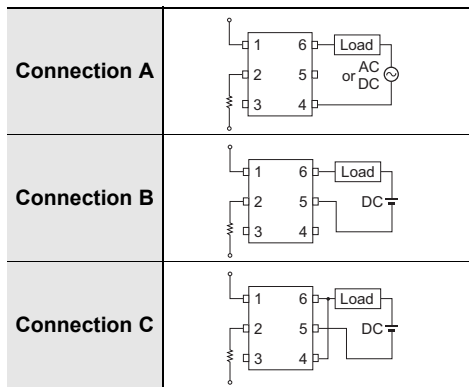

Electrical Characteristics (Ta = 25°C)

Item		Symbol		G3VM-63BR G3VM-63ER	Unit	Measurement conditions
Input	LED forward voltage	V _F	Minimum	1.1	V	I _F =10 mA
			Typical	1.27		
			Maximum	1.4		
	Reverse current	I _R	Maximum	10	μA	V _R =6 V
	Capacitance between terminals	C _T	Typical	70	pF	V=0 V, f=1 MHz
Trigger LED forward current	I _{FC}		Typical	0.3	mA	I _{OFF} =10 μA
			Maximum	2		
Release LED forward current	I _{FT}	Minimum	0.01	mA	I _O =1.2 A	
Output	Maximum resistance with output ON	R _{ON}	Typical	0.3	Ω	I _O =1.2 A
			Maximum	0.6		
			Typical	0.2		
			Typical	0.1		
Current leakage when the relay is open	I _{LEAK}		Maximum	10	μA	V _{OFF} =60 V, I _F =5 mA
				1		V _{OFF} =40 V, I _F =2 mA
Capacitance between terminals	C _{OFF}	Typical	550	pF	V=0 V, f=1 MHz, I _F =5 mA	
Capacitance between I/O terminals	C _{I-O}	Typical	0.9	pF	V _S =0 V, f=1 MHz	
Insulation resistance between I/O terminals	R _{I-O}		Minimum	1,000	MΩ	V _{I-O} =500 VDC, R _{oH} ≤ 60%
			Typical	10 ⁸		
Turn-ON time	t _{ON}		Typical	0.3	ms	I _F =5 mA, R _L =200 Ω, V _{DD} =20 V *
			Maximum	2		
Turn-OFF time	t _{OFF}		Typical	2		
			Maximum	3		

* Turn-ON and Turn-OFF times

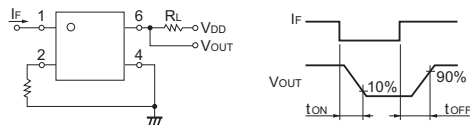

Recommended Operating Conditions

For usage with high reliability, Recommended Operation Conditions are measures that take into account the derating of Absolute Maximum Ratings and Electrical Characteristics.

Each item on this list is an independent condition, so they do not simultaneously satisfy several conditions.

Item	Symbol		G3VM-63BR G3VM-63ER	Unit
Load voltage (AC peak/DC)	V _{DD}	Maximum	48	V
Operating LED forward current	I _F	Typical	5	mA
		Maximum	10	
Continuous load current (AC peak/DC)	I _O	Maximum	1.2	A
Ambient operating temperature	T _a	Minimum	-20	°C
		Maximum	85	

Spacing and Insulation

Item	Minimum	Unit
Creepage distance	7.0	mm
Clearance distance	7.0	
Internal isolation thickness	0.3	

LED forward current vs. Ambient temperature

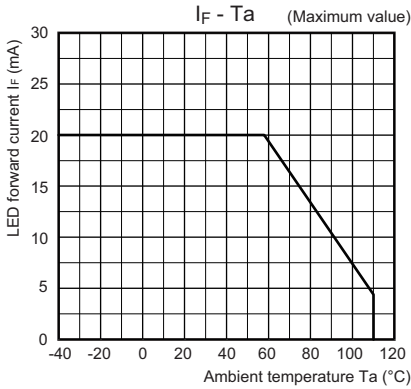

LED forward current vs. LED forward voltage

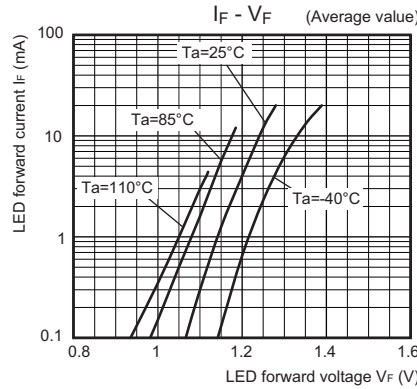

Continuous load current vs. Ambient temperature

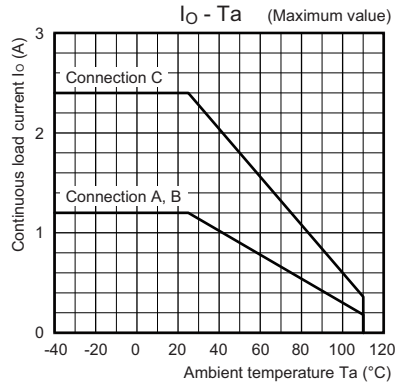

Continuous load current vs. On-state voltage

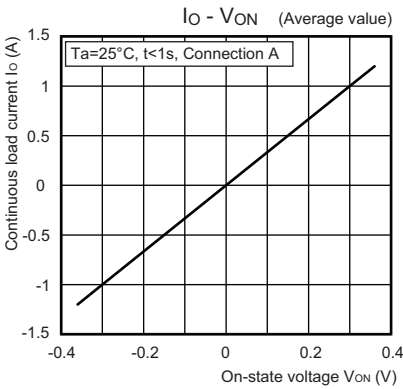

On-state resistance vs. Ambient temperature

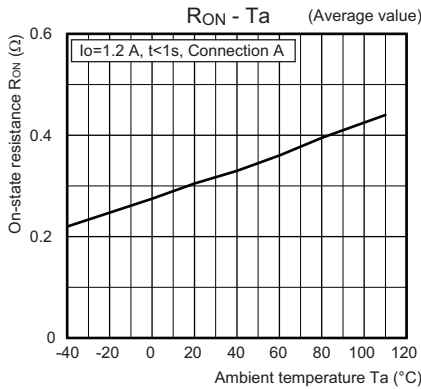

Trigger LED forward current vs. Ambient temperature

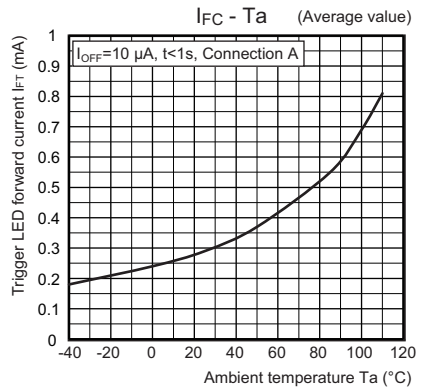

Turn ON, Turn OFF time vs. LED forward current

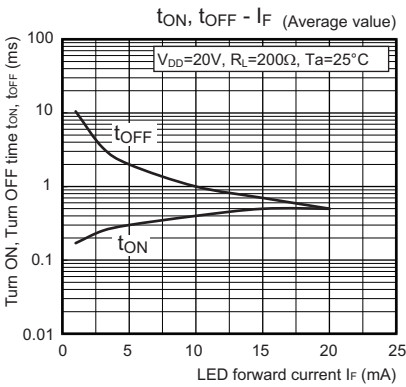

Turn ON, Turn OFF time vs. Ambient temperature

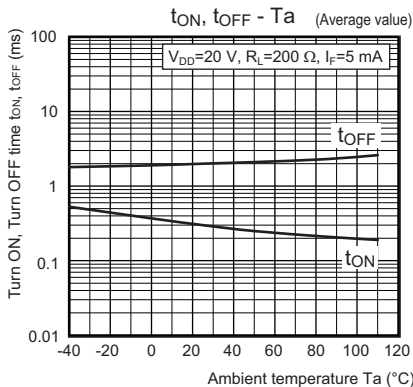

Current leakage vs. Ambient temperature

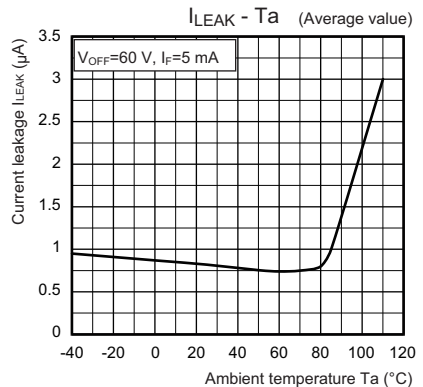

Current leakage vs. Load voltage

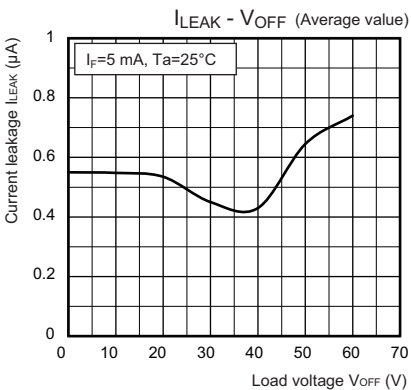

Current leakage vs. LED forward current

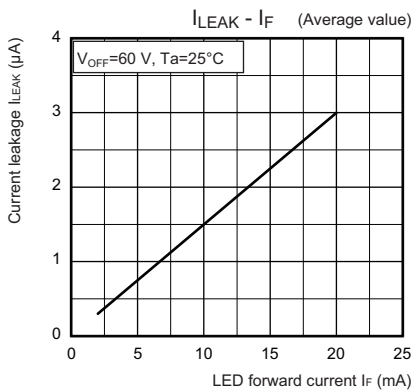

Note: About the "Current leakage vs. LED forward current" graph:

Take note that the current leakage is affected by the LED forward current input due to the internal mechanism of this model.

Appearance / Terminal Arrangement / Internal Connections

Appearance

DIP (Dual Inline Package)

DIP 6-pin

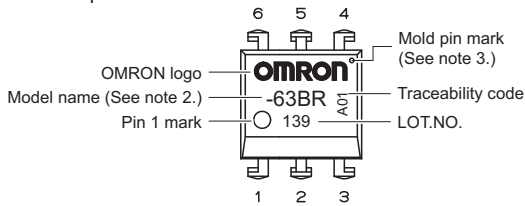

Terminal Arrangement/Internal Connections (Top View)

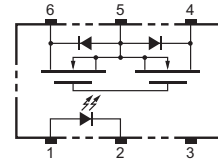

Note 1: The actual product is marked differently from the image shown here.

Note 2: "G3VM" does not appear in the model number on the relay.

Note 3: The indentation in the corner diagonally opposite from the pin 1 mark is from a pin on the mold.

Dimensions

CAD Data marked products. 2D drawings and 3D CAD models are available. For CAD information, please visit our website, which is noted on the last page.

(Unit: mm)

PCB Terminals

Weight: 0.4 g

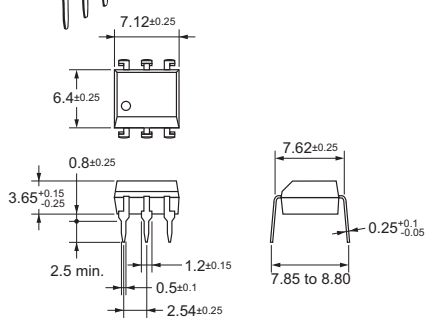

CAD Data

Surface-mounting Terminals

Weight: 0.4 g

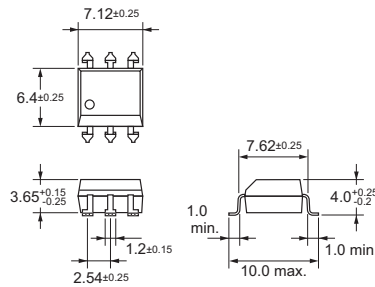

CAD Data

PCB Dimensions (BOTTOM VIEW)

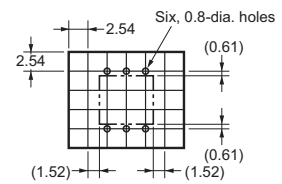

CAD Data

Actual Mounting Pad Dimensions (Recommended Value, Top View)

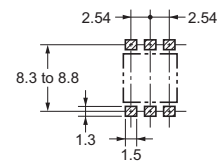

CAD Data

Note: The actual product is marked differently from the image shown here.

Safety Precautions

- Refer to the *Common Precautions for All MOS FET Relays* for precautions that apply to all MOS FET Relays.

Please check each region's Terms & Conditions by region website.

OMRON Corporation

Device & Module Solutions Company

Regional Contact

Americas

<https://components.omron.com/us>

Asia-Pacific

<https://components.omron.com/ap>

Korea

<https://components.omron.com/kr>

Europe

<https://components.omron.com/eu>

China

<https://components.omron.com.cn>

Japan

<https://components.omron.com/jp>