

# G8PM Relay

High Power PCB Relay for Automotive and DC 12 V Applications

## High Load Relay for Motor/Resistive/Lamp Control Applications

- Can replace Mini ISO Plug-in type relay
- Small size & High heat resistance enable for usage in engine room
- Can support 60A Fuse
- PIP reflow compliant
- Temperature range -40°C to +125°C



RoHS Compliant

### Model Number Legend

G8PM-□□□□□  
           1 2 3 4 5

- |   |  |  |
|---|--|--|
| <p><b>1. Number of Contact Poles</b><br/>1: 1-pole</p> <p><b>2. Contact Form</b><br/>A: SPST (1 Form A)</p> | <p><b>3. Contact structure</b><br/>W: Double contact</p> <p><b>4. Protective structure</b><br/>7: Flux tight (Open vent hole) (RT II IEC61810)</p> | <p><b>5. Special function</b><br/>R: Pin in paste compliant type</p> |
|---|--|--|

G8PM

### Application Examples

- DC motor/resistive/lamp application control
- Automotive DC applications (Smart Junction Box, Main power, Radiator fan, EPS, DC/DC converter, Head lamp, etc.)

### Ordering Information

Classification	Contact form	Protective structure	Rated coil voltage (V)	Model	Minimum Packing unit (Tube packing)
High power	SPST 1 Form A double contact	Flux tight (open vent hole) (RT II IEC61810)	DC12	G8PM-1AW7R DC12	1200 pcs. / box (40 pcs. x 30 tubes)

Note. Above models are not certificated for the safety standards of UL or CSA, etc.

### Ratings

#### Coil

Rated voltage (V)	Rated current (mA)	Coil resistance (Ω)	Must-operate voltage (V)	Must-release voltage (V)	Permissible voltage Range (V)	Rated Power consumption (mW)	Model
DC12	53.3	225	7.2 Max.	0.8 Min.	10 to 16	640	G8PM-1AW7R DC12

Note 1. The rated current and coil resistance are measured at a coil temperature of 20°C with a tolerance of ±10%.

Note 2. The operating characteristics are measured at a coil temperature of 20°C.

#### Contacts

Item	Classification	High power
	Model	G8PM-1AW7R DC12
Contact Type		Double
Contact material		Ag-alloy (Cd-free)
Rated continuous carry current	20°C	60 A
	125°C	40 A
Max. switching current		150 A Inrush 80 A break *1
Max. carrying current *2	135% fuse rating	81 A at DC14V for 1 h
	200% fuse rating	120 A at DC14V for 2 mins
Min. switching current		DC12V 0.1 A

\*1. Break current is DC14V resistive load 100 cycles at room temperature.

\*2. The data is measured at room temperature.

### ■ Characteristics

Item		G8PM-1AW
Contact resistance (See *1.)		Typ.2.5 mΩ Max. 50 mΩ
Operate time		10 ms max. (DC12V not including bounce time)
Release time		5 ms max. (DC12V not including bounce time)
Insulation resistance (See *2.)	Between coil and contacts	100 MΩ min.
	Between contacts of the same polarity	100 MΩ min.
Dielectric strength	Between coil and contacts	AC500V 1 min
	Between contacts of the same polarity	AC500V 1 min
Vibration resistance	Destruction	33 Hz, 45 m/s <sup>2</sup>
	Malfunction	10 to 500 Hz, 45 m/s <sup>2</sup> (detection time 10 μs min)
Shock resistance	Destruction	1,000 m/s <sup>2</sup> (pulse duration: 6 ms)
	Malfunction	100 m/s <sup>2</sup> (pulse duration: 11 ms detection time: 10 μs)
Mechanical endurance (See *3.)		1,000,000 ops. min.
Electrical endurance (See *4.)	Resistive Load	45 A, DC14V, 100,000 operations (1 s ON/1 s OFF)
	Lamp Load	100 A Inrush/ 20 A break, DC14V, 100,000 operations (1 s ON/9 s OFF)
Ambient operating temperature		-40 to 125°C (without freezing or condensation)
Ambient operating humidity		35% to 85% RH
Weight		Approx. 7.6 g

Note. The above values are initial values at an ambient temperature of +20°C unless otherwise specified.

\*1. The contact resistance was measured with 10 A at DC12V using the voltage drop method.

\*2. The insulation resistance was measured with a DC500V megohmmeter.

\*3. The mechanical endurance was measured at a switching frequency of 18,000 operations/hr.

\*4. Please connect N.O terminal to the +BATT side and connect surge suppression element in parallel between coil based on recommended circuit.

Recommended circuit: (a), (b), (c)

Not-recommended circuit: (d)

Note:

OMRON recommends coil driver circuit (b) and (c) for coil surge suppression. However the circuit (d) is not recommended because it may negatively affect the durability performance.

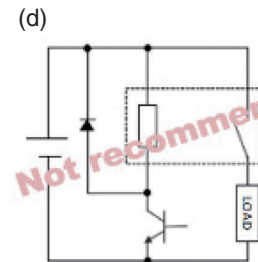
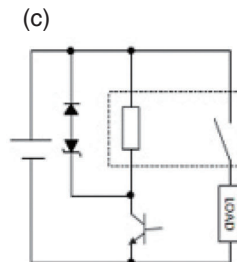
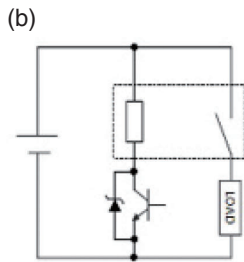
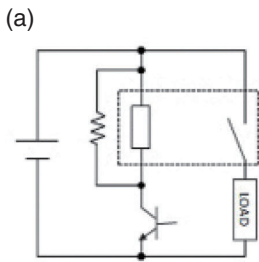

### Reference Technical Data

#### Actual Electrical performance (reference)

Model	Application	Load voltage	Inrush	Steady state	Switching off	Inductance	Ambient temperature	Switching frequency		Required Cycles (min)
		(V)	(A)	(A)	(A)			On (s)	Off (s)	
G8PM-1AW7R DC12	Radiator Fan	13.5	80	30	30		-40 to 110	3.0	8.0	156,000
G8PM-1AW7R DC12	Lamp	14	100	20	20	-	-40 to 110	0.5	5.5	156,000
G8PM-1AW7R DC12	Resistive	14	50	10	10	-	25	2.0	5.0	1,000,000
G8PM-1AW7R DC12	Fuel pump	14.7								
G8PM-1AW7R DC12	Starter Motor	14.5	150	50	50	0.16	-40 to 110	3.0	9.0	156,000

#### Must-operate Voltage and Must-release Voltage Distributions (Number of Relays × Percentage of Rated Voltage)

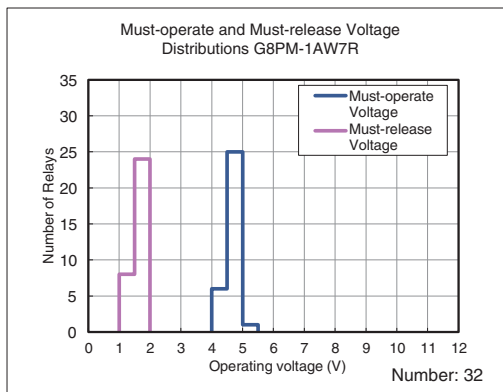

#### Time Characteristic Distributions (Number of Contacts × Time (ms))

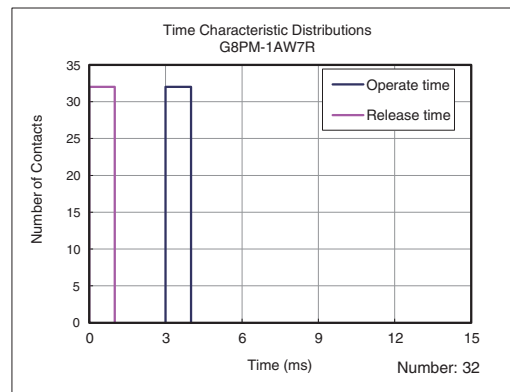

#### Operating voltage vs ambient temperature (Cold start)

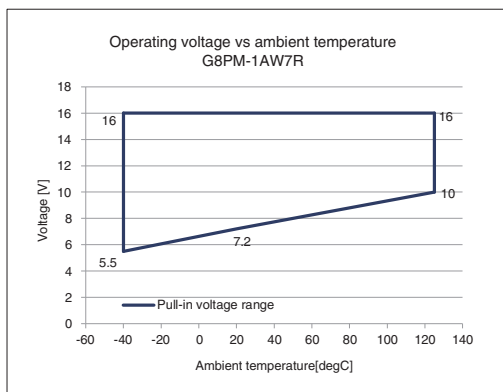

#### Coil temperature rise [degC] at 20°C

(For using under a higher ambient temperature, please select the proper current carrying condition to avoid a possible excessive temperature rising.)

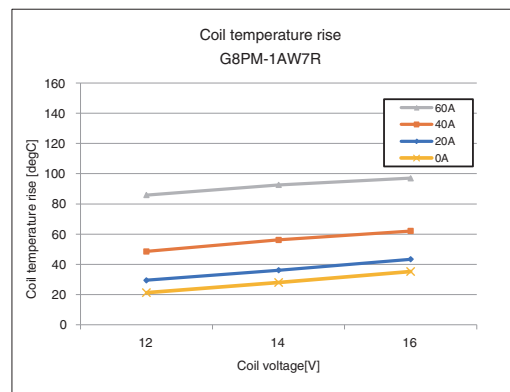

#### Derating curve

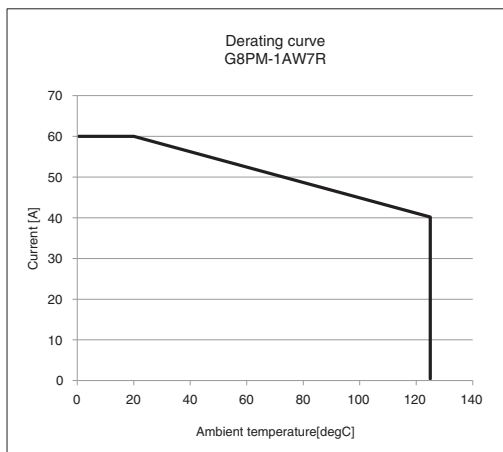

# G8PM

## High Power PCB Relay for Automotive and DC 12 V Applications

### ■ Dimensions

**CAD Data** Please visit our website, which is noted on the last page.

(Unit: mm)

#### G8PM

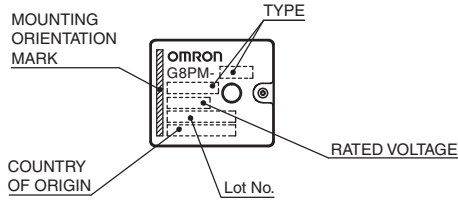

#### PCB Mounting Holes (Bottom View)

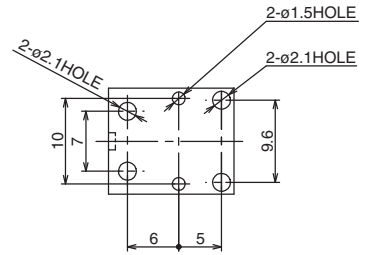

\*Please study & choose other appropriate hole diameters if confirmed the diameter values recommended above don't work with the soldering process.

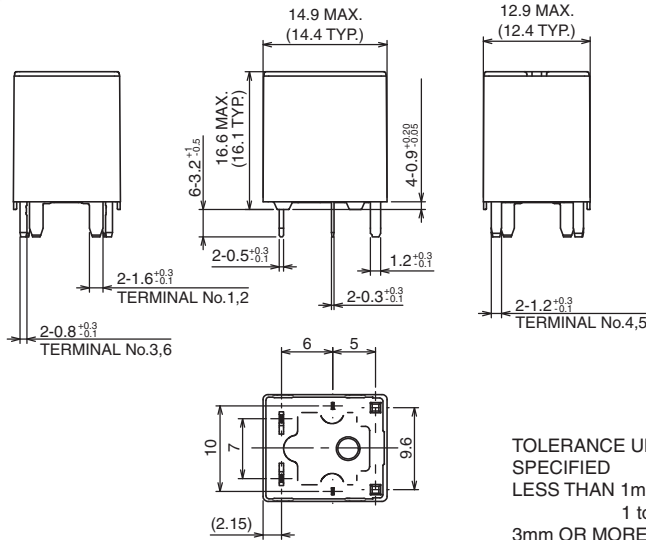

#### Terminal Arrangement/ Internal Connections (Bottom View)

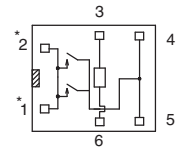

NOTE: \*TERMINAL 1&2 CONNECT TO +BATT

TOLERANCE UNLESS OTHERWISE SPECIFIED  
 LESS THAN 1mm : ±0.1mm  
 1 to 3mm : ±0.2mm  
 3mm OR MORE : ±0.3mm

**CAD Data**

### ■Precautions

- Please refer to “Safety Precautions for All Automotive Relays” for correct use.

Please check each region's Terms & Conditions by region website.

### OMRON Corporation Electronic and Mechanical Components Company

#### Regional Contact

**Americas**

<https://www.components.omron.com/>

**Asia-Pacific**

<https://ecb.omron.com.sg/>

**Korea**

<https://www.omron-ecb.co.kr/>

**Europe**

<http://components.omron.eu/>

**China**

<https://www.ecb.omron.com.cn/>

**Japan**

<https://www.omron.co.jp/ecb/>