

# Photomicrosensor (Transmissive)

# EE-SX1046

## Horizontal Mounting Slot/Terminal Type (Slot Width: 3 mm)

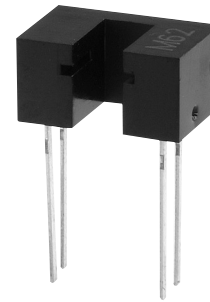

- Horizontal aperture type
- Terminal for PCB mounting



Be sure to read *Safety Precautions* on Page 3.

## Ordering Information

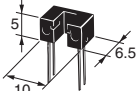
### Photomicrosensor

Appearance	Sensing method	Connecting method	Sensing distance	Aperture size (H × W) (mm)	Output type	Model	Minimum packing unit (Unit: pcs)
	Transmissive (slot type)	Terminal for PCB mounting	 3 mm (Slot width)	Both emitting side and detecting side 0.5 × 1.3	Phototransistor	EE-SX1046	1

Note: Order in multiples of minimum packing unit.

## Ratings, Characteristics and Exterior Specifications

### Absolute Maximum Ratings (Ta = 25°C)

Item	Symbol	Rated value	Unit
<b>Emitter</b>			
Forward current	$I_F$	50*1	mA
Pulse forward current	$I_{FP}$	1*2	A
Reverse voltage	$V_R$	4	V
<b>Detector</b>			
Collector-Emitter voltage	$V_{CEO}$	30	V
Emitter-Collector voltage	$V_{ECO}$	—	V
Collector current	$I_C$	20	mA
Collector dissipation	$P_C$	100*3	mW
Operating temperature	$T_{opr}$	-25 to 85	°C
Storage temperature	$T_{stg}$	-30 to 100	°C
Soldering temperature	$T_{sol}$	260*3	°C

\*1. Refer to the temperature rating chart if the ambient temperature exceeds 25°C.

\*2. Pulse width ≤ 10 μs, Repeated 100 Hz

\*3. Complete soldering within 10 seconds.

### Exterior Specifications

Connecting method	Weight (g)	Material
		Case
Terminal for PCB mounting	0.3	Polycarbonate

### Electrical and Optical Characteristics (Ta = 25°C)

Item	Symbol	Value			Unit	Condition
		MIN.	TYP.	MAX.		
<b>Emitter</b>						
Forward voltage	$V_F$	—	1.2	1.5	V	$I_F = 30$ mA
Reverse current	$I_R$	—	0.01	10	μA	$V_R = 4$ V
Peak emission wavelength	$\lambda_P$	—	920	—	nm	$I_F = 20$ mA
<b>Detector</b>						
Light current	$I_L$	1.2	—	14	mA	$I_F = 20$ mA, $V_{CE} = 5$ V
Dark current	$I_D$	—	2	200	nA	$V_{CE} = 10$ V, 0 lx
Leakage current	$I_{LEAK}$	—	—	—	μA	—
Collector-Emitter saturated voltage	$V_{CE(sat)}$	—	0.1	0.4	V	$I_F = 20$ mA, $I_L = 0.1$ mA
Peak spectral sensitivity wavelength	$\lambda_P$	—	850	—	nm	$V_{CE} = 10$ V
Rising time	$t_r$	—	4	—	μs	$V_{CC} = 5$ V, $R_L = 100$ Ω, $I_L = 5$ mA
Falling time	$t_f$	—	4	—	μs	$V_{CC} = 5$ V, $R_L = 100$ Ω, $I_L = 5$ mA

# Engineering Data (Reference Value)

**Fig 1. Forward Current vs. Collector Dissipation Temperature Rating**

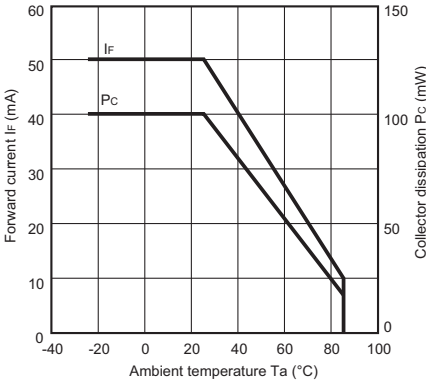

**Fig 2. Forward Current vs. Forward Voltage Characteristics (Typical)**

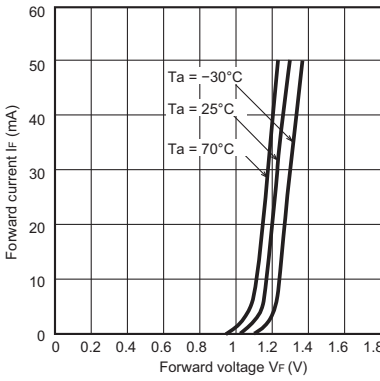

**Fig 3. Light Current vs. Forward Current Characteristics (Typical)**

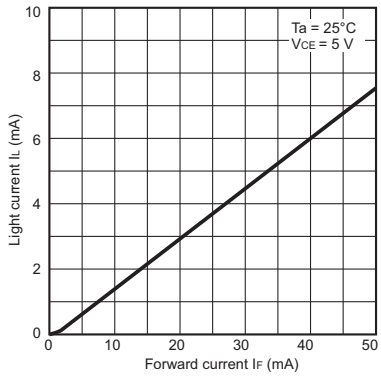

**Fig 4. Light Current vs. Collector-Emitter Voltage Characteristics (Typical)**

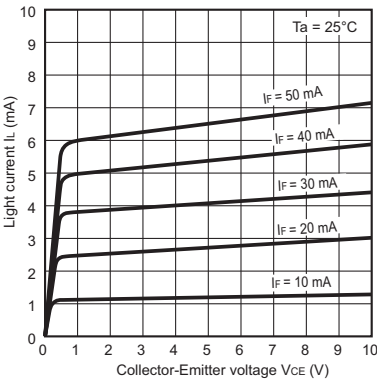

**Fig 5. Relative Light Current vs. Ambient Temperature Characteristics (Typical)**

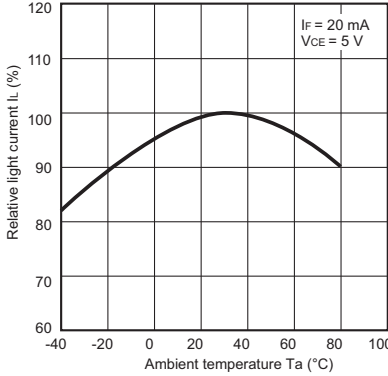

**Fig 6. Dark Current vs. Ambient Temperature Characteristics (Typical)**

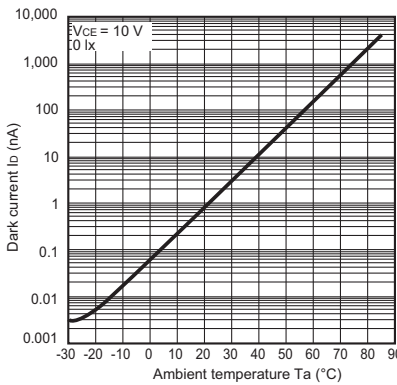

**Fig 7. Response Time vs. Load Resistance Characteristics (Typical)**

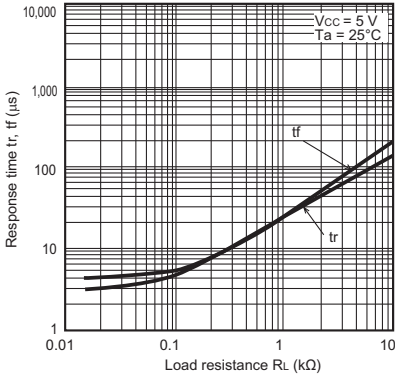

**Fig 8. Sensing Position Characteristics (Typical)**

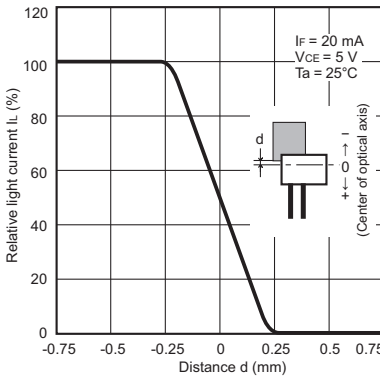

**Fig 9. Sensing Position Characteristics (Typical)**

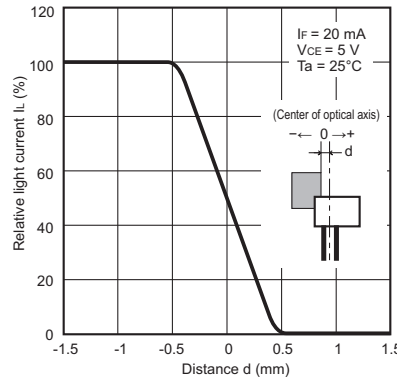

**Fig 10. Response Time Measurement Circuit**

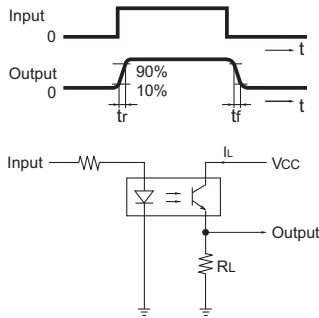

# Safety Precautions

To ensure safe operation, be sure to read and follow the Instruction Manual provided with the Sensor.

**CAUTION**

This product is not designed or rated for ensuring safety of persons either directly or indirectly. Do not use it for such purposes.

**Precautions for Correct Use**

Do not use the product in atmospheres or environments that exceed product ratings.

**Precautions for Safe Use**

**Do not use the product with a voltage or current that exceeds the rated range.**

Applying a voltage or current that is higher than the rated range may result in explosion or fire.

**Do not miswire such as the polarity of the power supply voltage.**

Otherwise the product may be damaged or it may burn.

**This product does not resist water. Do not use the product in places where water or oil may be sprayed onto the product.**

## Dimensions and Internal Circuit

(Unit: mm)

### Photomicrosensor

EE-SX1046



Aperture size (H x W)

Emitter	Detector
0.5 x 1.3	0.5 x 1.3

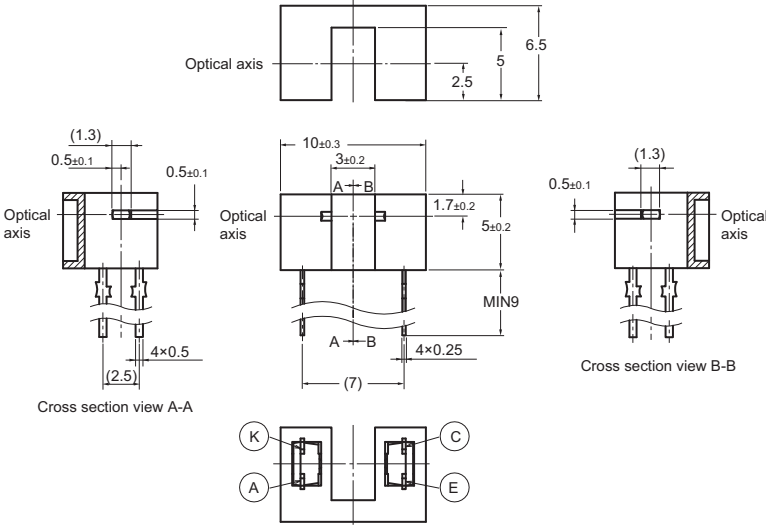

Internal circuit

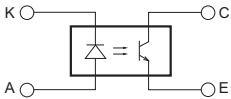

Terminal No.	Name
A	Anode
K	Cathode
C	Collector
E	Emitter

Unless otherwise specified, the tolerances are as shown below.

Dimensions	Tolerance
3 mm max.	±0.3
3 < mm ≤ 6	±0.375
6 < mm ≤ 10	±0.45
10 < mm ≤ 18	±0.55
18 < mm ≤ 30	±0.65

Please check each region's Terms & Conditions by region website.

---

## **OMRON Corporation**

**Device & Module Solutions Company**

### **Regional Contact**

#### **Americas**

<https://components.omron.com/us>

#### **Asia-Pacific**

<https://components.omron.com/ap>

#### **Korea**

<https://components.omron.com/kr>

#### **Europe**

<https://components.omron.com/eu>

#### **China**

<https://components.omron.com.cn>

#### **Japan**

<https://components.omron.com/jp>